

Invia[®] Liberty[™]

NEGATIVE PRESSURE WOUND THERAPY SYSTEM

- EN Patient instructions for use
- DE Gebrauchsanweisung für Patienten
- FR Mode d'emploi pour le patient
- ES Instrucciones de uso para el paciente
- PT Instruções de utilização para pacientes
- NL Gebruiksaanwijzing voor patiënten
- SV Bruksanvisning för patienter
- IT Istruzioni per l'uso per il paziente
- FI Käyttöohjeet potilaalle
- DA Brugsanvisning til patienter
- NO Bruksanvisning for pasient



Assistance

Read the entire instruction manual before trying to operate the device.

If you have any questions about your Invia Liberty Negative Pressure Wound Therapy system, please contact your healthcare provider/physician at the number below:

HEALTHCARE PROVIDER/PHYSICIAN
CONTACT INFORMATION:

Keep this Patient instructions for use (IFU) booklet in an easily accessible location.

Table of contents



Warnings, cautions and safety instructions	4
General warnings.....	4
Purpose of the device	6
Intended use.....	6
When to use the the device (Indications for use)	7
When not to use the device (Contraindications)	7
Description of the device	8
Display	9
Conditions that affect use	9
General safety at home	10
Sleeping	11
Showering, bathing and washing	11
When you leave the house	12
Set up instructions	12
Set up carrying case	14
Charge battery	14
Change canister	16
Connect / disconnect Quick-connector	17
Notifications and troubleshooting	19
Alarm table	20
Cleaning / Disinfection	24
Guarantee	24
Maintenance / Safety-related check	24
Disposal	24
Technical specifications	25
Signs and symbols	26
Electromagnetic compatibility (EMC)	29

Warnings, cautions and safety instructions



WARNING

Indicates a potentially hazardous situation which, if not avoided, could result in death or serious injury.



CAUTIONS

Indicates a potentially hazardous situation which, if not avoided, could result in minor or moderate injury.

General warnings



WARNING

The individual responsible for operating this device on a daily basis (patient, caregiver) must be able to read, understand and follow directions provided in this IFU, on the pump display and by the healthcare professional. The individual must be able to hear and respond to auditory signals.

Only use the Invia Liberty NPWT system on the person for whom it was ordered and only for its intended use.

Do not perform the therapy without first consulting with healthcare personnel and caregivers trained on the instructions for use and the healthcare professional's supervision.

No modification of this equipment is allowed.



WARNING

Visually check at the wound dressing and the Invia Liberty system frequently.

If you see large amounts of blood in the dressing, tubing or canister:

- 1 Turn off the pump by pressing  and hold for 3 seconds.
- 2 Apply pressure to your wound.
- 3 Seek immediate Emergency Medical assistance.



If you have difficulty breathing, seek immediate Emergency Medical Assistance.

 **WARNING**

Immediately contact your healthcare professional if you experience the following symptoms:

- Significant vision or hearing loss
- Pain, soreness or redness around the wound
- Swelling, itching, or rash around the wound
- Fever
- Strong odor from the wound
- Thick green drainage or any unusual change in color of drainage
- Nausea or vomiting or diarrhea
- Sore throat with swelling
- Dizziness or confusion
- Allergic reactions like redness, rash or hives, swelling or severe itching

 **WARNING**

Once the healthcare professional has set the pump pressure and mode settings do not press any other button than the on/off button [], the standby button [] or the mute button [].

 **WARNING**

The pump must be used 24 hours per day. Do not stop the pump unless instructed by your healthcare professional or if excessive bleeding occurs.

If the pump is stopped for more than 2 hours, the dressing must be changed. Contact your healthcare professional to request a dressing change.

 **WARNING**

If the pump stops working and cannot be switched on, immediately call your healthcare professional.

Purpose of the device

Your healthcare provider has prescribed Negative Pressure Wound Therapy (NPWT) for you.

Negative Pressure Wound Therapy has been shown to help promote healing in several different kinds of wounds. Negative pressure (suction) is delivered to a wound through a pump. The suction, or negative pressure, helps to remove fluid and close your wound. Your healthcare professional will place a special dressing on your wound and a tube will go from your wound to the canister on the pump. The pump is then turned on to the prescribed pressure to remove the fluid from your wound. The fluid then goes into the canister. The treatment will be on 24 hours a day.

Intended use

Intended user

The Invia Liberty NPWT system is intended to be used by healthcare professionals or adequately trained lay users. Healthcare professionals are responsible to train lay users according to the patient instructions for use and explain all related safety information.

Intended patient population

The Invia Liberty NPWT system is intended to be used on patients only exhibiting conditions as described in the indications for use. The device has not been studied in pediatric patients.

Intended environment

The Invia Liberty NPWT system is intended for use in acute, extended and home care settings.

When to use the device (Indications for use)

The Invia Liberty Negative Pressure Wound Therapy (NPWT) system is indicated for patients who would benefit from a suction device (NPWT) as it creates an environment that promotes wound healing by secondary or tertiary (delayed primary) intention by preparing the wound bed for closure, reducing edema, promoting granulation tissue formation and perfusion, and by removing exudate and infectious material.

When used on closed surgical incisions, the Invia Liberty NPWT system is also intended to manage the environment of surgical incisions that continue to drain following sutured or stapled closure by maintaining a closed environment and removing exudate via the application of Negative Pressure Wound Therapy.

The Invia Liberty NPWT system is appropriate for the following indications:

- Acute or subacute wounds
- Chronic wounds
- Dehisced wounds
- Pressure ulcers
- Diabetic/Neuropathic ulcers
- Venous insufficiency ulcers
- Traumatic wounds
- Partial thickness burns
- Flaps and grafts
- Closed surgical incisions

When not to use the device (Contraindications)

The Invia Liberty NPWT system is contraindicated in the presence of:

- Necrotic tissue with eschar present
- Untreated osteomyelitis
- Non-enteric and unexplored fistulas
- Malignancy in the wound
- Exposed vasculature
- Exposed nerves
- Exposed anastomotic site of blood vessels or bypasses
- Exposed organs

If you have concerns, speak with your healthcare professional.

Description of the device

Check the delivery package of the Invia Liberty system for completeness and general condition.

WARNING

Do not use any other accessories than the ones described below.

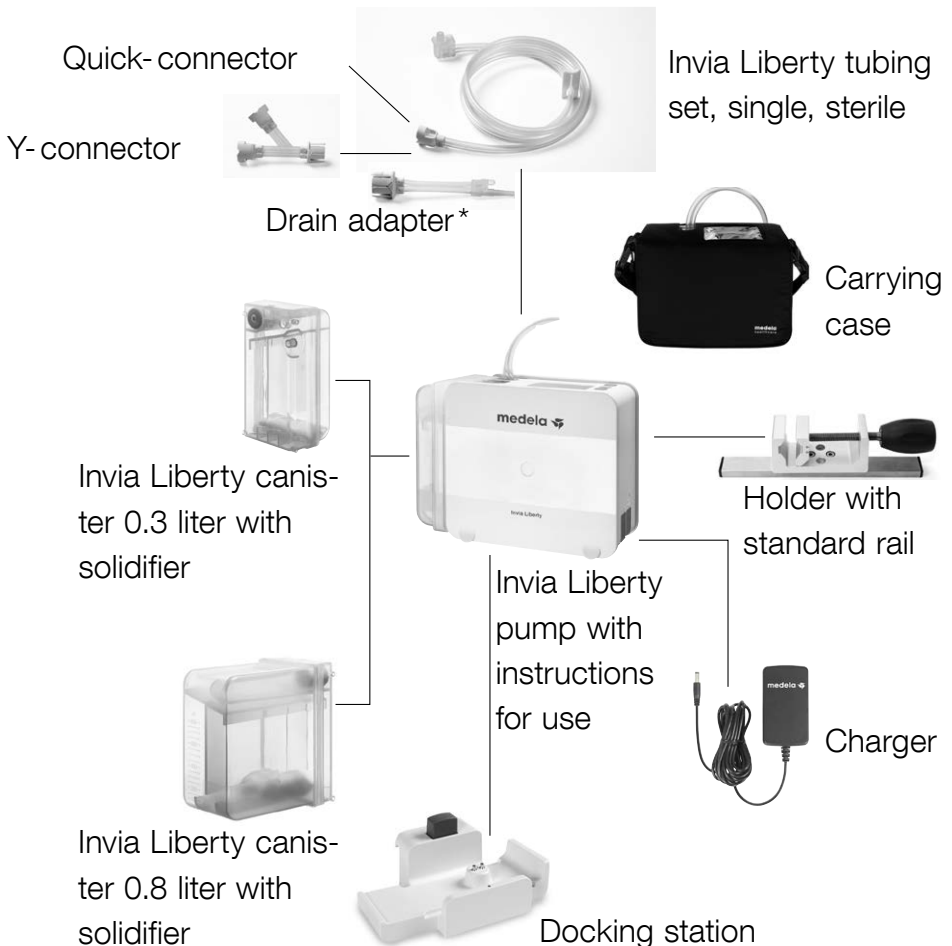

* Product not available in all countries

Display

Buttons to operate the Invia Liberty pump

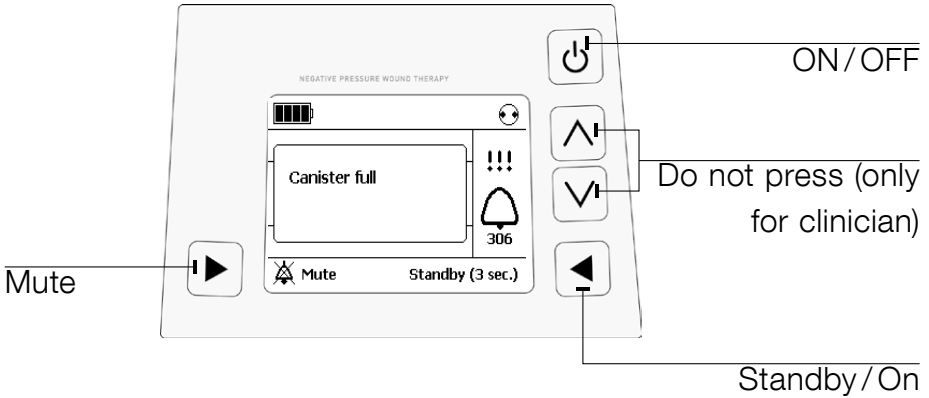

Conditions that affect use



CAUTION

The Invia Liberty pump must remain in an upright position during use.



General safety at home



Please read and observe these warnings and safety instructions before operation. These instructions for use must be kept with the device. Please note that these instructions for use are a general guide for the use of the product. Medical situations must be addressed by a physician.



CAUTIONS / WARNINGS

- Do not use extension cords with the Invia Liberty pump.
- Position the power cord so that it will not cause someone to trip and fall.
- Never place the power supply cord around your neck.
- Keep the power supply cord away from hot surfaces.
- Do not unplug the power supply cord from the wall outlet by pulling on the cord.
- Do not try to fix or repair the Invia Liberty pump. Contact your healthcare professional if the pump is not working.
- Keep the Invia Liberty pump clean and dry.
- Never place the Invia Liberty pump in water or liquids.
- If the Invia Liberty pump gets wet, dry with a towel.
- Do not dry the Invia Liberty pump in a microwave.
- Keep the Invia Liberty pump away from children and pets.
- Supervision is necessary when the Invia Liberty pump is used in the vicinity of children.
- Keep the Invia Liberty pump protected from direct sunlight.
- Explosion hazard – the Invia Liberty pump is not for use in potentially explosive environments including oxygen enriched environments and in areas of flammable anesthetics.
- Wireless communication equipment such as wireless home network devices, mobile phones, cordless telephones and their base stations, and walkie-talkies can interfere with the Invia Liberty pump and should be kept at a minimum distance of 30 cm away from the Invia Liberty pump. This may cause insufficient battery charging or may lead to an inter-

nal fault. See the chapter Notifications and troubleshooting for actions to take in the case of an internal fault.

- This product contains lithium-ion batteries which bear risk of fire, explosion and burns. Do not disassemble, crash, heat above 100°C, incinerate or dispose of in fire.

If you observe a change in the vacuum level or an error condition, move the Invia Liberty pump at least 30 cm from the mobile phone when making or receiving calls. Turn the Invia Liberty pump on and off again to reset it after an error condition. Whenever possible, a safety distance of minimum 30 cm between the Invia Liberty pump and a mobile phone is recommended.

Sleeping



- Make sure the Invia Liberty pump tubing will not become kinked.
- Prevent the Invia Liberty pump from falling to the floor during sleep.
- Always charge the Invia Liberty pump when going to bed.

Showering, bathing and washing



- Do not use the Invia Liberty pump while bathing or showering.
- The Invia Liberty pump can be disconnected from the dressing for a short period of time (up to 20 minutes) in order to change clothes or perform personal hygiene. Discuss bathing plans with your healthcare professional.
- Prevent the Invia Liberty pump from getting wet.
- Do not put the Invia Liberty pump where it can fall into a shower, sink or tub.
- Do not touch the Invia Liberty pump when it has fallen into water. Unplug device immediately from electrical outlet and disconnect the pump from the dressing.

When you leave the house



- Check the battery status and recharge if necessary before leaving the house.
- For your convenience, place the Invia Liberty pump into the carrying case.
- Do not forget to take a spare canister and power supply with you.

Set up instructions



WARNING

Check the Invia Liberty pump and dressing frequently to make sure it is working. Visually check the wound dressing, area around the wound and fluid in the canister for signs of infection or other complications as provided by your healthcare professional.

Turn ON

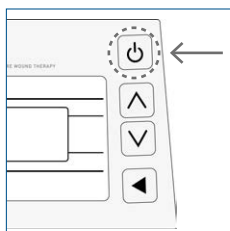

Switch Invia Liberty pump ON by pressing [].

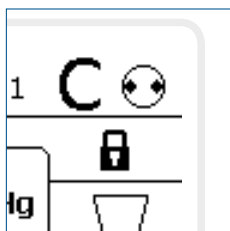

Display view when the pump is running. Run/Standby indicator is rotating [].

**WARNING**

Do not try to perform therapy without the supervision of your healthcare professional.

**WARNING**

NPWT must run 24 hours a day. Do not stop the therapy unless instructed by your healthcare professional or if excessive bleeding occurs.

**WARNING**

The dressing should be changed and therapy restarted by the healthcare professional if therapy is discontinued for more than 2 hours.

**WARNING**

Invia Liberty pump does not detect blockage along tubing connected to the drain adapter or connected to the curved arm of the Y-connector. Check dressing tubing connected to the drain adapter or the curved arm of the Y-connector frequently throughout the day to make sure tubing is not kinked or blocked.

If blockage is identified along tubing connected to the drain adapter or tubing connected to the curved arm of the Y-connector, contact your healthcare professional.

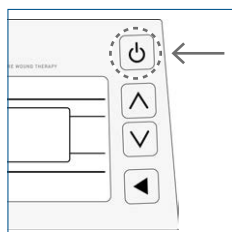
**Turn OFF**

Switch Invia Liberty pump OFF by pressing [] for 3 seconds. Press only once.

Set up carrying case

The Invia Liberty pump is intended to be worn in a carrying case during operation.



- 1 Open the carrying case.
- 2 Slide the Invia Liberty pump into the designated pocket.
- 3 Close the velcro over the pump.

The shoulder strap can also be used as a belt strap. To accomplish this, release the strap at the sides of the carrying case and pull it through the two loops located on the back of the carrying case.

Charge battery

When the battery is fully charged the battery run-time generally exceeds 14 hours. If the Invia Liberty pump is running continuously due to an air leakage, the battery may need to be recharged earlier.

Battery status symbols



full



half full



fully discharged (empty)

If the battery becomes fully discharged (empty), please follow the instructions below.

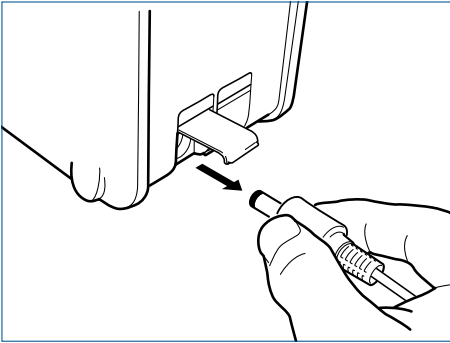

Open the electrical outlet port. Connect the Invia Liberty pump to the supplied electrical plug from the power supply provided with the pump. Plug the other end of the power supply into a wall outlet. Moving bars on the battery display will indicate charging is occurring.

The battery is fully charged after approximately 4 hours. Once battery is fully charged and continues to be connected to the power source  will appear constantly on the display. After charging is completed, unplug the power supply from the wall and disconnect the Invia Liberty pump from the power supply. Close the electrical outlet port by pressing the protection cover down.



CAUTION

NPWT therapy must be continued while charging the pump's battery. Do not turn the pump off while charging.

Always charge the battery overnight.

Electrical outlet port



Change canister

Change canister minimum once a week or when it appears full or when the alarm sounds, in accordance with instructions on the pump display.

- 1 Wash hands.
- 2 Press the "Standby" button [ > 3 seconds] and the pump motor will stop running.

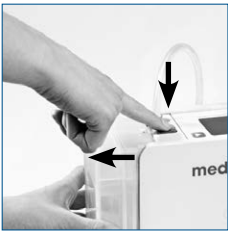
- 3  Press release button at the top of the pump and remove canister.

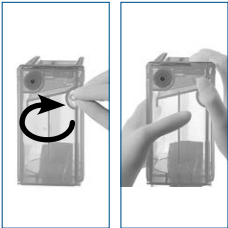
- 4  Seal used canister with a cap located on the side of the canister.

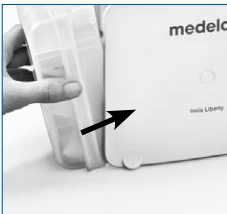
- 5  Unpack new canister and remove the safety sticker, position the feet at the bottom of the canister into the grooves at the base of the pump. Push the canister up and click into the Invia Liberty pump.



CAUTION

Do not use an Invia Liberty canister if the sterile packaging is damaged.

6



Switch the Invia Liberty pump on by pressing "On" [] to resume therapy and slide the pump into the carrying case.

7 Discard the used canister according to instructions provided by your healthcare professional.

Connect/disconnect Quick-connector

The Quick-connector can be disconnected for a short period of time (up to 20 minutes) in order to change clothes or perform personal hygiene. During this time the pump can be placed in the "Standby" mode for a 5 minute interval, after which time the "Standby mode" alarm will go off and can be muted for an additional 5 minutes.

1 Wash hands.

2 Close the clamp on canister tubing and close the clamp on the dressing tubing.



3 Press the "Standby" button [ > 3 seconds] and the pump motor will stop running.

4

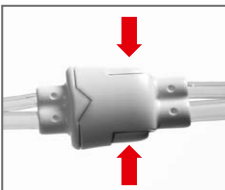

Disconnect the Quick-connector by pressing under the sides of the connector.

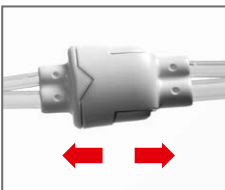

5

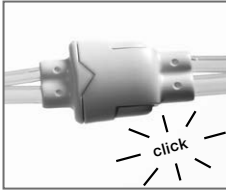
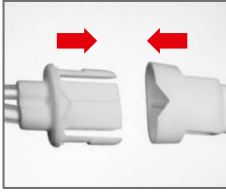

To reconnect the Quick-connector push together the Quick-connector until you hear the click.

6



Open the clamp on canister tubing and open the clamp on the dressing tubing.

7

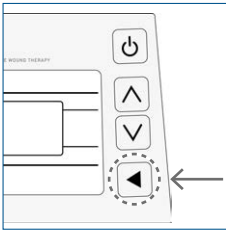

Press "On" [◀] to resume therapy.

Notifications and troubleshooting



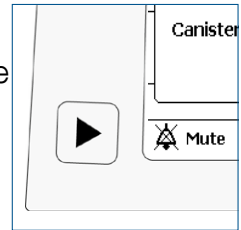

Do not panic if an acoustic signal sounds.
Follow the instructions below.

- 1 If the Invia Liberty pump is in the carrying case open the lid of your carrying case.
- 2 Press [] to mute the acoustic signal for 60 seconds (can be pressed every time the signal sounds).

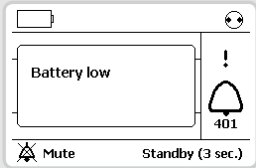
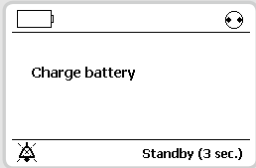
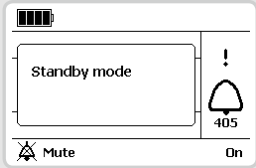
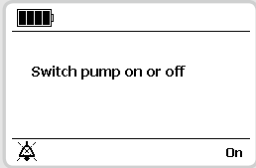
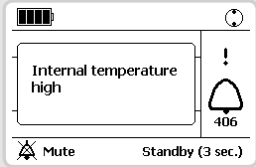
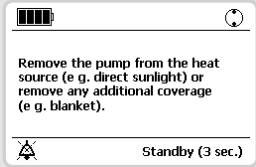
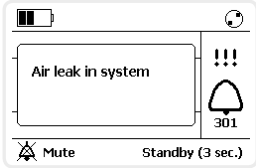
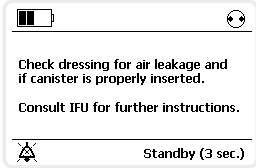
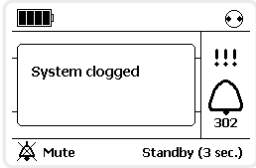
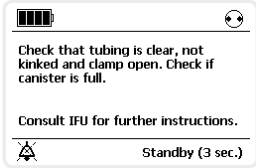

Alarm table

Warning	401		
	405		
	406		
Alarm	301		
	302		

	Remarks/potential cause of fault
	<p>Recharge the battery either by placing the Invia Liberty pump in the docking station or plug in the charger to the electrical outlet port on the pump.</p> <p>Remaining time of battery is approximately 30 minutes.</p>
	<p>If the pump is in Standby mode for more than 5 minutes, an alarm will go off.</p> <p>To continue therapy press “On” []</p>
	<p>Cool Invia Liberty pump down as per instructions on the display.</p>
	<p>Dressing:</p> <ul style="list-style-type: none"> - Check dressing for air leakage. Press firmly around the edges of the dressing, around the drain tubing or on the Invia FitPad. - May apply additional film dressing to seal the leaking area. <p>Connectors:</p> <ul style="list-style-type: none"> - Ensure that the tubing connected to the dressing is connected properly to the canister tubing. - Ensure that the canister tubing is inserted straight into the pump. <p>Canister:</p> <ul style="list-style-type: none"> - Ensure that the canister is properly inserted, release the canister and reposition. - Ensure that the orange O-ring/gasket, placed beside the canister tubing on the pump is not missing. Additional O-ring is available via Medela representative.
	<p>Call your healthcare professional.</p>

Alarm	305		
	306		
	311		
	313		
Internal fault			



CAUTION

If you are unable to identify any symbol or do not understand the alarm on the display, contact your healthcare professional.

	Remarks/potential cause of fault
	<p>Recharge the battery either by placing the Invia Liberty pump in the docking station or plug in the charger to the electrical outlet port on the pump.</p> <p>Remaining time of battery is approximately 15 minutes.</p>
	<p>Change the canister, see chapter “Change canister”.</p>
	<p>Canister: - Release the canister and reposition. Tubing: - Ensure that the tubing is not twisted, kinked or clamped.</p>
	<p>Change canister, see chapter “Change canister”.</p>
	<p>Restart the pump. If internal fault remains, turn off by pressing [ > 3 seconds] and contact your healthcare professional.</p>



WARNING

If the pump fails or cannot be switched on call your healthcare professional immediately.

Cleaning / Disinfection



The Invia Liberty pump can be wiped with a damp cloth using a mild household cleaner.

Guarantee



Warranty period is for 2 years after date of delivery. The manufacturer is not liable for any damage or consequential damage caused by incorrect operation, inappropriate usage as well as use by unauthorized persons.

Maintenance / Safety-related check



Service work may only be carried out by authorized personnel. A safety-related check is confined to visual inspection of the housing and charger for damage and must be performed prior to each use. If Invia Liberty pump has not been in use, the battery must be charged approximately once every 6 months to ensure optimum function.

Disposal



Ask your healthcare professional how to dispose of used dressings, canisters and tubing.

Technical specifications



Accessories storage conditions

Accessories must remain in the packaging and stored at a temperature range of -20° Celsius and $+50^{\circ}$ Celsius.



Operation environmental conditions

The Invia Liberty pump and accessories must be operated within a temperature range of $+5^{\circ}$ Celsius and $+40^{\circ}$ Celsius. Do not operate the products in extreme cold or heat. Avoid high relative humidity (15–93% is permissible).



CAUTION

Do not operate the Invia Liberty pump above 3000 meter above sea level.

Protection Class IP33

IP33

The Invia Liberty pump is protected against ingress of solids larger than 2.5 millimeter and dripping water.

Signs and symbols



This symbol indicates a CAUTION or WARNING associated with the device.



This symbol indicates a class II device.



Do not dispose the device together with unsorted municipal waste (for EU only).



This symbol indicates the date of manufacture (four digits for the year and two digits for the month).



This symbol indicates the name and the address of the manufacturer.



This symbol indicates that this is a prescription device. CAUTION: U.S. Federal law restricts this device to sale by or on the order of a physician (for US only).



This symbol indicates a type BF applied part.



This symbol indicates manufacturer's catalog number.



This symbol indicates manufacturer's serial number.



This symbol indicates manufacturer's batch code.

STERILE|EO

This symbol indicates the device is sterilized using ethylene oxide.



This symbol indicates that the device should not be used after the end of the year and month shown.



This symbol indicates to follow the Instruction for use.



This symbol indicates the compliance with additional USA and Canada safety requirements for medical electrical equipment.



This symbol indicates to not use the device if package is damaged.

IP33

This symbol indicates the protection against the ingress of solid foreign objects and against harmful effects due to the ingress of water.



This symbol indicates that the marked item or its material is part of a recovery or recycling process.



This symbol indicates the humidity limitation for operation and storage.



This symbol indicates the atmospheric pressure limitation for operation and storage.



This symbol indicates to keep the device dry.

pcs

This symbol indicates the number of items.



This symbol indicates the direct current socket.



This symbol indicates a single use device. Do not reuse the device.



This symbol indicates the temperature limitation for operation, transport and storage.



This symbol indicates to keep the device away from sunlight.



This symbol indicates to handle the fragile device with care.



This symbol indicates that the device is in conformance with the Medical Device Directive 93/42/EEC.



This symbol indicates the correct upright position of the transport package.

Electromagnetic compatibility (EMC)

Invia Liberty is EMC-tested in conformity with the requirements of IEC 60601-1-2:2007 and IEC 60601-1-2:2014 4th Edition according clause 7 and 8.9.



WARNING

The Invia Liberty pump should not be used adjacent to or stacked with other equipment. If adjacent or stacked use is necessary, the Invia Liberty pump should be observed to verify normal operation in the configuration in which it will be used.



WARNING

Do not use other accessories than those specified or sold by the manufacturer as replacement parts for internal components as it may result in increased emissions or decreased immunity of the Invia Liberty pump.



WARNING

EMC

HF (high-frequency) surgical equipment, radio networks or the like can influence the operation of the device and may not be operated in combination with the Invia Liberty pump.

Hilfe

Bitte lesen Sie die ganze Gebrauchsanweisung durch, bevor Sie das Gerät in Betrieb nehmen.

Falls Sie Fragen zu Ihrem Invia Liberty Unterdruck-Wundtherapie System haben, wenden Sie sich bitte an Ihre Pflegefachkraft/ Ihren Arzt:

KONTAKTINFORMATIONEN
PFLEGEKRAFT/ARZT:

Bewahren Sie diese Gebrauchsanweisung für Patienten an einem gut zugänglichen Ort auf.

Inhaltsverzeichnis

Warn-, Vorsichts- und Sicherheitsanweisungen	32
Allgemeine Warnhinweise	32
Zweck des Gerätes	34
Zweckbestimmung	34
Wann wird das Gerät verwendet (Indikationen)	35
Wann darf das Gerät nicht verwendet werden (Kontraindikationen)	35
Gerätebeschreibung	36
Display	37
Bedingungen, die den Gebrauch beeinträchtigen	37
Allgemeine Sicherheit zu Hause	38
Schlafen	39
Duschen, baden und waschen	40
Wenn Sie das Haus verlassen	40
Montageanleitung	40
Tragevorrichtung einrichten	42
Akku laden	42
Behälter wechseln	44
Quick-Connector anschließen/trennen	45
Meldungen und Fehlerbehebung	47
Alarmübersicht	48
Reinigung/Desinfektion	52
Garantie	52
Wartung/Sicherheitskontrolle	52
Entsorgung	52
Technische Daten	53
Zeichen und Symbole	54
Elektromagnetische Verträglichkeit (EMV)	57

Warn-, Vorsichts- und Sicherheitsanweisungen

ACHTUNG

Weist auf eine potenziell gefährliche Situation hin, die zum Tod oder zu ernsthaften Verletzungen führen kann.

VORSICHT

Weist auf eine potenziell gefährliche Situation hin, die zu kleineren bis mittelschweren Verletzungen führen kann.

Allgemeine Warnhinweise

ACHTUNG

Die Person, die für den täglichen Betrieb dieses Geräts verantwortlich ist (Patient, Pflegeperson), muss in der Lage sein, die Anweisungen in dieser Gebrauchsanweisung, auf dem Display der Pumpe und vonseiten der Pflegefachkraft zu verstehen und zu befolgen. Die Person muss über ein normales Hörvermögen verfügen und auf Tonsignale reagieren können.

Das Invia Liberty Unterdruck-Wundtherapie System darf nur an der Person angewendet werden, für die es bestellt wurde, und ausschließlich für den vorgesehenen Zweck.

Führen Sie die Therapie nicht ohne vorherige Beratung durch medizinisches Fachpersonal und Pflegekräfte durch, die zu den Gebrauchsanweisungen geschult wurden, sowie unter Aufsicht des medizinischen Fachpersonals.

An dem Gerät dürfen keine Veränderungen vorgenommen werden.

ACHTUNG

Führen Sie häufig eine optische Kontrolle von Wundverband und Invia Liberty System durch.

Falls Sie große Mengen Blut im Verband, Schlauch oder Behälter bemerken:

- 1 Pumpe abschalten, indem Sie  3 Sekunden lang gedrückt halten.
- 2 Druck auf die Wunde ausüben.
- 3 Sofort den medizinischen Notfalldienst in Anspruch nehmen.



Falls Sie Atemnot haben, wenden Sie sich sofort an den medizinischen Notfalldienst.

ACHTUNG

Wenden Sie sich sofort an Ihr medizinisches Fachpersonal, wenn Sie die folgenden Symptome haben:

- Starke Beeinträchtigung des Sehens oder Hörens
- Schmerzen, Entzündung oder Rötung im Wundbereich
- Schwellung, Jucken oder Ausschlag in der Wundumgebung
- Fieber
- Starker Geruch aus der Wunde
- Abgesaugte Flüssigkeit ist zähflüssig, grünlich oder in anderer ungewöhnlicher Farbe verfärbt
- Übelkeit, Erbrechen oder Durchfall
- Halsschmerzen mit Schwellung
- Schwindel oder Verwirrtheit
- Allergische Reaktionen wie Rötung, Ausschlag oder Nesselsucht, Schwellung oder starkes Jucken

ACHTUNG

Sobald das medizinische Fachpersonal den Pumpendruck und die Moduseinstellungen festgelegt hat, drücken Sie keine andere Taste als die Ein-/Ausschalttaste [], die Standby-Taste [] oder die Stumm-Taste [].

ACHTUNG

Die Pumpe muss 24 Stunden pro Tag verwendet werden. Unterbrechen Sie die Pumpe nicht, außer Ihr medizinisches Fachpersonal fordert Sie dazu auf oder es kommt zu übermäßigem Bluten.

Wird die Pumpe für mehr als zwei Stunden abgeschaltet, muss der Verband gewechselt werden. Wenden Sie sich für einen Verbandwechsel an Ihr medizinisches Fachpersonal.

ACHTUNG

Falls die Pumpe nicht mehr läuft und nicht wieder eingeschaltet werden kann, rufen Sie sofort Ihr medizinisches Fachpersonal an.

Zweck des Gerätes

Ihr Arzt hat Ihnen eine Unterdruck-Wundtherapie (NPWT) verschrieben. Unterdruck-Wundtherapie unterstützt nachweislich die Heilung verschiedener Wundarten. Unterdruck (Sog) entsteht an der Wunde durch eine Pumpe. Dieser Sog bzw. Unterdruck trägt dazu bei, dass die Flüssigkeit aus Ihrer Wunde entfernt und diese geschlossen wird. Das medizinische Fachpersonal wird einen besonderen Verband auf Ihrer Wunde anbringen sowie einen Schlauch, der von der Wunde zum Behälter an der Pumpe führt. Die Pumpe wird dann mit einem voreingestellten Unterdruck eingeschaltet, um die Flüssigkeit aus Ihrer Wunde zu entfernen. Die Wundflüssigkeit fließt dann in den Behälter. Die Behandlung erfolgt 24 Stunden am Tag.

Zweckbestimmung

Vorgesehene Anwender

Das Invia Liberty Unterdruck-Wundtherapie System ist für den Einsatz durch medizinisches Fachpersonal oder entsprechend geschulte Laien vorgesehen.

Das medizinische Fachpersonal ist dafür verantwortlich, Laienanwender entsprechend der Gebrauchsanweisung für Patienten zu schulen und ihnen alle Sicherheitsinformationen zu erklären.

Patientenzielgruppe

Das Invia Liberty Unterdruck-Wundtherapie System ist ausschließlich für den Einsatz an Patienten mit den in der Gebrauchsanweisung aufgeführten Beschwerden vorgesehen. Das Gerät wurde nicht an pädiatrischen Patienten geprüft.

Vorgesehene Umgebung

Das Invia Liberty Unterdruck-Wundtherapie System ist für den Einsatz im Krankenhaus, Pflegeheim und auch Zuhause bestimmt.

Wann wird das Gerät verwendet (Indikationen)

Das Invia Liberty Unterdruck-Wundtherapie (NPWT) System ist für Patienten indiziert, für die ein Absauggerät (NPWT) vorteilhaft wäre, weil es eine Umgebung schafft, die die sekundäre und tertiäre (verzögerte primäre) Wundheilung fördert, indem es das Wundbett für den Wundverschluss vorbereitet, Ödeme abbaut, die Bildung von Granulationsgewebe und die Durchblutung fördert sowie Wundflüssigkeit und infektiöses Material entfernt.

Bei der Anwendung auf geschlossenen chirurgischen Inzisionen ist das Invia Liberty Unterdruck-Wundtherapie System durch Erhalt einer geschlossenen Umgebung und Entfernen von Exsudat durch die Anwendung der Unterdruck-Wundtherapie ebenfalls zur Behandlung der Umgebung von chirurgischen Inzisionen indiziert, die nach dem Vernähen oder Klammern weiterhin Flüssigkeit absondern.

Das Invia Liberty Unterdruck-Wundtherapie System ist für die folgenden Indikationen geeignet:

- akute oder subakute Wunden
- chronische Wunden
- dehiszierte Wunden
- Dekubitus
- diabetische/neuropathische Ulcera
- venöse Ulcera cruris
- traumatische Wunden
- Verbrennungen zweiten Grades
- Haut- und Gewebetransplantationen
- geschlossene chirurgische Inzisionen

Wann darf das Gerät nicht verwendet werden (Kontraindikationen)

Das Invia Liberty Unterdruck-Wundtherapie System ist kontraindiziert bei:

- Gewebenekrosen mit Verschorfungen
- unbehandelter Osteomyelitis
- nicht enterischen und nicht untersuchten Fisteln
- malignen Wunden
- freiliegenden Blutgefäßen
- freiliegenden Nerven
- freiliegenden Anastomosenbereichen von Blutgefäßen oder Bypässen
- freiliegenden Organen

Wenden Sie sich bei Bedenken an das medizinische Fachpersonal.

Gerätebeschreibung

Überprüfen Sie, ob das gelieferte Paket des Invia Liberty Systems alle Bestandteile enthält und in gutem Zustand ist.



ACHTUNG

Benutzen Sie kein anderes Zubehör als das unten beschriebene.

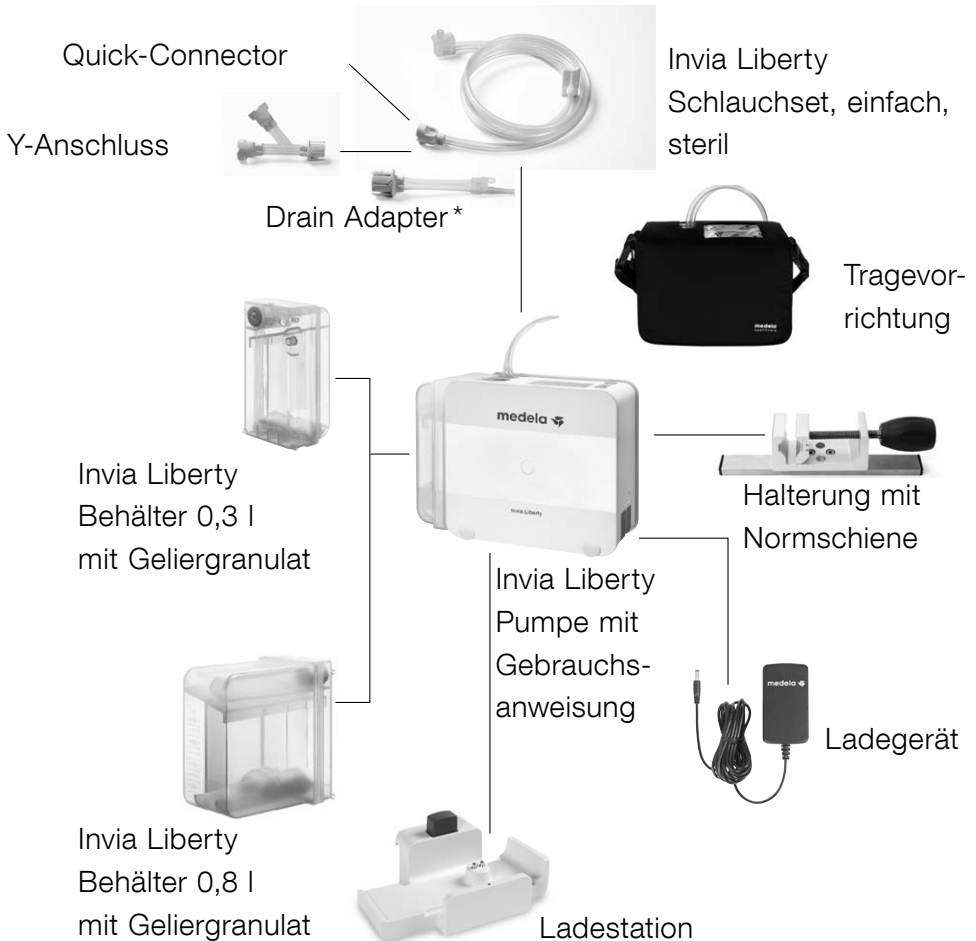

* Produkt ist nicht in allen Ländern erhältlich

Display

Tasten zur Bedienung der Invia Liberty Pumpe

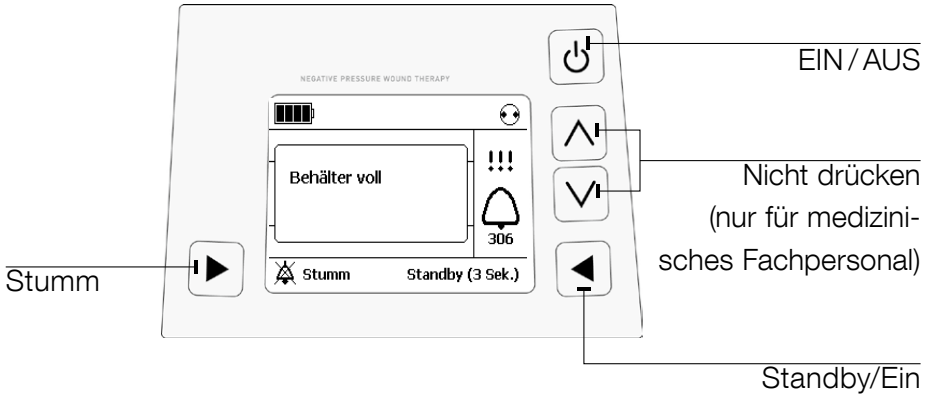

Bedingungen, die den Gebrauch beeinträchtigen



VORSICHT

Während des Gebrauchs muss die Invia Liberty Pumpe aufrecht stehen.



Allgemeine Sicherheit zu Hause



Vor Inbetriebnahme bitte diese Warn- und Sicherheitshinweise lesen und beachten. Diese Gebrauchsanweisung muss mit dem Gerät aufbewahrt werden. Bitte beachten Sie, dass diese Gebrauchsanweisung allgemeine Angaben zur Verwendung des Produktes enthält. Zur Klärung medizinischer Fragen wenden Sie sich bitte an einen Arzt.

VORSICHT/ACHTUNG

- Verwenden Sie keine Verlängerungskabel mit der Invia Liberty Pumpe.
- Positionieren Sie das Stromkabel so, dass niemand darüber stolpern und hinfallen kann.
- Legen Sie das Stromkabel nie um Ihren Hals.
- Stromkabel nicht mit heißen Flächen in Berührung bringen.
- Ziehen Sie das Stromkabel niemals durch Ziehen am Kabel aus der Steckdose.
- Versuchen Sie nicht, die Invia Liberty Pumpe zu reparieren. Wenden Sie sich an das medizinische Fachpersonal, wenn die Pumpe nicht funktioniert.
- Halten Sie die Invia Liberty Pumpe sauber und trocken.
- Die Invia Liberty Pumpe nie in Wasser oder andere Flüssigkeiten stellen.
- Falls die Invia Liberty Pumpe nass wird, mit einem Tuch trocken reiben.
- Die Invia Liberty Pumpe nicht in einer Mikrowelle trocknen.
- Die Invia Liberty Pumpe von Kindern und Haustieren fernhalten.
- Überwachung ist nötig, wenn die Invia Liberty Pumpe in der Nähe von Kindern verwendet wird.
- Die Invia Liberty Pumpe vor direktem Sonnenlicht schützen.
- Explosionsgefahr – die Invia Liberty Pumpe darf nicht in explosionsgefährdeten Bereichen eingesetzt werden, darunter sauerstoffangereicherte Umgebungen und Bereichen mit entflammbar Anästhetika.
- Drahtlose Kommunikationsdienste wie drahtlose Heimnetzwerke, Mobiltelefone, schnurlose Telefone und deren Basisstationen sowie Sprechfunkgeräte können die Funktionsweise der Invia Liberty

Pumpe beeinträchtigen und sollten mit einem Mindestabstand von 30 cm von der Invia Liberty Pumpe ferngehalten werden. Dies kann zu einem unzureichenden Aufladen des Akkus führen oder einen internen Fehler verursachen. Siehe Kapitel „Meldungen und Fehlerbehebung“ für Maßnahmen bei einem internen Fehler.

- Dieses Produkt enthält Lithium-Ionen-Akkus, von denen eine Brand-, Explosions- und Verbrennungsgefahr ausgeht. Sie dürfen nicht auseinandergenommen, zerbrochen, über 100 °C erhitzt, verbrannt oder in ein Feuer geworfen werden.

Wenn Sie eine Veränderung der Vakuumstärke oder einen Fehlerzustand bemerken, halten Sie die Invia Liberty Pumpe mindestens 30 cm vom Mobiltelefon entfernt, wenn Sie Anrufe tätigen oder annehmen. Schalten Sie die Invia Liberty Pumpe nach einem Fehlerzustand aus und wieder ein. Falls möglich, wird ein Sicherheitsabstand von mindestens 30 cm zwischen der Invia Liberty Pumpe und einem Mobiltelefon empfohlen.

Schlafen



- Achten Sie darauf, dass die Schläuche der Invia Liberty Pumpe nicht geknickt werden.
- Verhindern Sie, dass die Invia Liberty Pumpe während des Schlafens auf den Boden fällt.
- Laden Sie immer den Akku der Invia Liberty Pumpe auf, während Sie schlafen.

Duschen, baden und waschen



- Verwenden Sie die Invia Liberty Pumpe nicht beim Baden oder Duschen.
- Die Invia Liberty Pumpe kann für eine kurze Zeit (bis zu 20 Minuten) vom Verband getrennt werden, um die Kleidung zu wechseln oder Körperpflege zu betreiben. Besprechen Sie Ihre Badepläne mit dem medizinischen Fachpersonal.
- Verhindern Sie, dass die Invia Liberty Pumpe nass wird.
- Stellen Sie die Invia Liberty Pumpe nicht an einen Ort, wo sie in eine Dusche, ein Waschbecken oder eine Badewanne fallen kann.

- Berühren Sie die Invia Liberty Pumpe nicht, wenn sie ins Wasser gefallen ist. Ziehen Sie den Stecker sofort aus der Steckdose und trennen Sie die Pumpe vom Verband.

Wenn Sie das Haus verlassen



- Überprüfen Sie den Ladezustand des Akkus und laden Sie ihn falls nötig auf, bevor Sie das Haus verlassen.
- Verwenden Sie die praktische Tragevorrichtung der Invia Liberty Pumpe.
- Vergessen Sie nicht, einen Ersatzbehälter und das Ladegerät mitzunehmen.

Montageanleitung



ACHTUNG

Kontrollieren Sie die Invia Liberty Pumpe und den Verband häufig, um den Betrieb sicherzustellen. Kontrollieren Sie den Wundverband, den Wundbereich und die Flüssigkeit im Behälter auf sichtbare Anzeichen einer Infektion oder andere Komplikationen, wie vom medizinischen Fachpersonal vorgegeben.

Einschalten

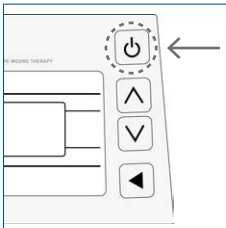

Die Invia Liberty Pumpe mit [] einschalten.

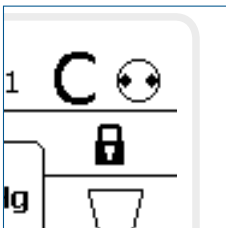

Displayanzeige, wenn die Pumpe in Betrieb ist. Anzeige laufender Betrieb/Standby dreht sich [].



ACHTUNG

Versuchen Sie nicht, die Behandlung ohne Aufsicht durch das medizinische Fachpersonal durchzuführen.



ACHTUNG

NPWT muss 24 Stunden am Tag durchgeführt werden. Unterbrechen Sie die Therapie nicht, außer das medizinische Fachpersonal fordert Sie dazu auf oder es kommt zu übermäßigem Bluten.



ACHTUNG

Wenn die Therapie für mehr als 2 Stunden unterbrochen wird, sollte der Verband gewechselt und die Therapie durch das medizinische Fachpersonal neu begonnen werden.



ACHTUNG

Die Invia Liberty Pumpe erkennt keine Blockaden im Schlauch, der am Drainageadapter oder am gekrümmten Abzweig des Y-Anschlusses angeschlossen ist. Kontrollieren Sie häufig im Laufe des Tages den Drainageschlauch, der am Drainageadapter oder am gekrümmten Abzweig des Y-Anschlusses angeschlossen ist, um sicherzustellen, dass der Schlauch nicht geknickt bzw. blockiert ist.

Falls eine Blockade entlang des Schlauchs festgestellt wird, der am Drainageadapter oder am gekrümmten Abzweig des Y-Anschlusses angeschlossen ist, wenden Sie sich an das medizinische Fachpersonal.

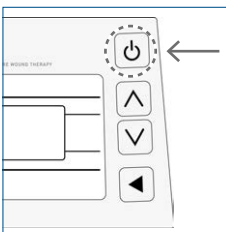

Ausschalten

Die Invia Liberty Pumpe ausschalten, indem Sie [] 3 Sekunden lang drücken. Nur einmal drücken.

Tragevorrichtung einrichten

Die Invia Liberty Pumpe ist darauf ausgelegt, während des Betriebs in einer Tragevorrichtung getragen zu werden.



- 1 Öffnen Sie die Tragevorrichtung.
- 2 Schieben Sie die Invia Liberty Pumpe in das dafür vorgesehene Fach.
- 3 Schließen Sie den Klettverschluss über der Pumpe.

Der Schulterriemen kann auch als Hüftriemen um den Bauch getragen werden.

Dafür lösen Sie den Riemen an den Seiten der Tragevorrichtung und ziehen Sie ihn durch die beiden Laschen, die sich auf der Rückseite der Tragevorrichtung befinden.

Akku laden

Wenn der Akku vollständig aufgeladen ist, beträgt die Akkulaufzeit in der Regel mehr als 14 Stunden. Falls die Invia Liberty Pumpe wegen einer Luftleckage ununterbrochen läuft, muss der Akku möglicherweise früher wieder aufgeladen werden.

Symbole zum Akkustand



voll



halb voll



vollständig entladen (leer)

Ist der Akku vollständig entladen (leer), befolgen Sie bitte die nachstehenden Anweisungen.

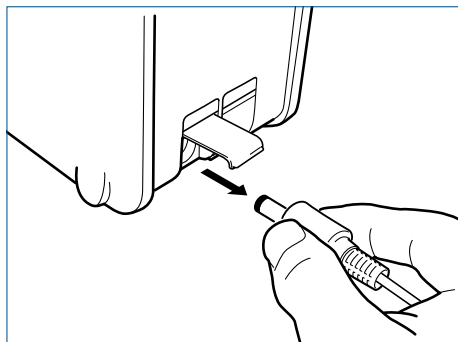

Stromanschluss öffnen. Die Invia Liberty Pumpe mit dem zugehörigen Ladegerät der Pumpe verbinden. Das andere Ende des Ladegeräts in eine Steckdose stecken. Die Akkuanzeige im Display zeigt, dass der Akku geladen wird.

Der Akku ist nach etwa 4 Stunden vollständig aufgeladen. Sobald der Akku vollständig aufgeladen und weiterhin mit dem Stromnetz verbunden ist, erscheint  konstant auf dem Display. Nach dem Aufladen des Akkus das Ladegerät aus der Steckdose ziehen und die Invia Liberty Pumpe von der Stromversorgung trennen. Schließen Sie den Stromanschluss, indem Sie die Schutzabdeckung herunterdrücken.



VORSICHT

Die NPWT-Therapie muss während des Ladens des Pumpenakkus fortgesetzt werden. Pumpe während des Ladens nicht ausschalten.

Akku immer über Nacht aufladen.

Netzadapter-Anschluss

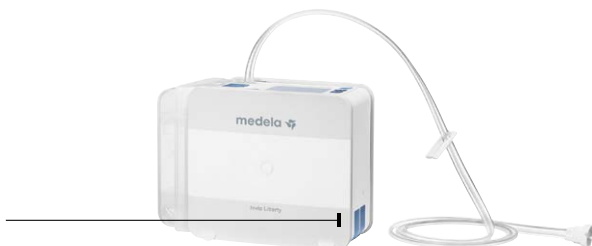

Behälter wechseln

Wechseln Sie den Behälter mindestens einmal pro Woche oder wenn der Behälter voll zu sein scheint oder nach Ertönen des Alarms gemäß den Anweisungen auf dem Pumpendisplay.

1 Hände waschen.

2 Drücken Sie „Standby“ [ > 3 Sekunden] und der Pumpenmotor wird ausgeschaltet.

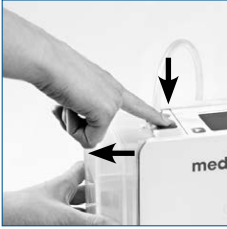
3  Entriegelungsknopf an der Oberseite der Pumpe drücken und Behälter entfernen.

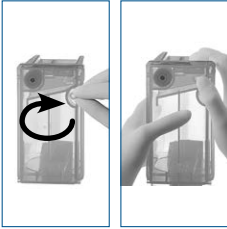
4  Den benutzten Behälter mit einer Kappe verschließen, die sich an der Seite des Behälters befindet.

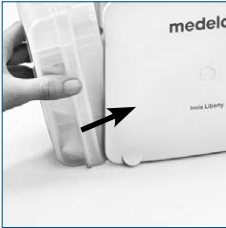
5  Neuen Behälter auspacken und den Sicherheitsaufkleber entfernen, die Noppen im unteren Teil des Behälters in die Vertiefungen unten an der Pumpe führen. Den Behälter nach oben drücken und in die Invia Liberty Pumpe einrasten.



VORSICHT

Verwenden Sie den Invia Liberty Behälter nicht, wenn die sterile Verpackung beschädigt ist.

6



Schalten Sie die Invia Liberty Pumpe durch Drücken von „Ein“ [] an, um die Therapie fortzusetzen, und schieben Sie die Pumpe zurück in die Tragevorrichtung.

- 7 Benutzten Behälter entsprechend den Anweisungen des medizinischen Fachpersonals entsorgen.

Quick-Connector anschließen/trennen

Der Quick-Connector kann für eine kurze Zeit (bis zu 20 Minuten) getrennt werden, um die Kleidung zu wechseln oder Körperpflege zu betreiben. Während dieser Zeit kann die Pumpe 5 Minuten lang in den Standby-Modus geschaltet werden. Danach ertönt der Alarm „Standby-Modus“ und kann für weitere 5 Minuten stumm geschaltet werden.

- 1 Hände waschen.
- 2 Die Klemme am Pumpenschlauch und die Klemme am Drainageschlauch schließen.



- 3 Drücken Sie „Standby“ [ > 3 Sekunden] und der Pumpenmotor wird ausgeschaltet.

4

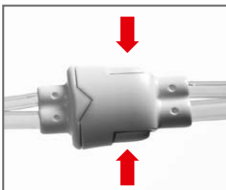

Den Quick-Connector durch seitliches Drücken auf den Quick-Connector lösen.

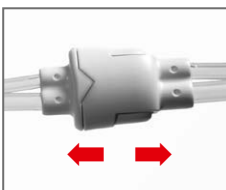

5

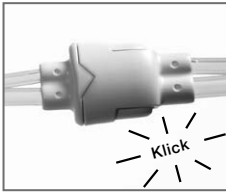
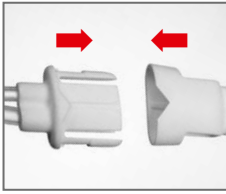

Zum erneuten Anschließen des Quick-Connectors den Quick-Connector zusammendrücken, bis ein Klicken zu hören ist.

6



Die Klemme am Pumpenschlauch und die Klemme am Drainageschlauch öffnen.

7

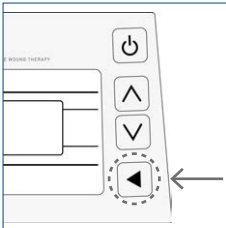

„Ein“ [▶] drücken, um die Therapie fortzusetzen.

Meldungen und Fehlerbehebung



Geraten Sie nicht in Panik, wenn ein akustisches Signal ertönt. Befolgen Sie die nachstehenden Anweisungen.

- 1 Falls sich die Invia Liberty Pumpe in der Tragevorrichtung befindet, öffnen Sie diese.
- 2 Drücken Sie [], um das akustische Signal 60 Sekunden lang stumm zu schalten (kann jedes Mal gedrückt werden, wenn der Signalton ertönt).

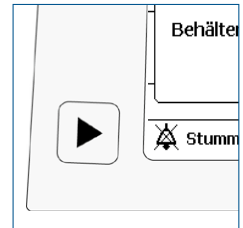

Alarmübersicht

Achtung	401		
	405		
	406		
Alarm	301		
	302		

	Bemerkungen/mögliche Fehlerursache
	<p>Den Akku folgendermaßen aufladen: Entweder die Invia Liberty Pumpe in die Ladestation stellen oder das Ladegerät an den Stromanschluss an der Pumpe anschließen.</p> <p>Die verbleibende Akkulaufzeit liegt bei ca. 30 Minuten.</p>
	<p>Wenn die Pumpe länger als 5 Minuten im Standby-Modus ist, wird ein Alarm ausgelöst.</p> <p>Zur Fortsetzung der Therapie „Ein“ [] drücken.</p>
	<p>Die Invia Liberty Pumpe gemäß den Anweisungen auf dem Display abkühlen lassen.</p>
	<p>Verband:</p> <ul style="list-style-type: none"> – Verband auf Luftleckagen überprüfen. Verband an den Rändern, um den Drainageschlauch und am Invia FitPad fest andrücken. – Eventuell zusätzlich Folienverband benutzen, um die undichte Stelle abzudichten. <p>Konnektoren:</p> <ul style="list-style-type: none"> – Sicherstellen, dass der Drainageschlauch am Pumpenschlauch korrekt angeschlossen ist. – Sicherstellen, dass der Pumpenschlauch gerade an der Pumpe angeschlossen ist. <p>Behälter:</p> <ul style="list-style-type: none"> – Sicherstellen, dass der Behälter korrekt eingesetzt ist, den Behälter entriegeln und wieder einsetzen. – Sicherstellen, dass der orangefarbene O-Ring/Dichtungsring neben dem Pumpenschlauch an der Pumpe nicht fehlt. Ein zusätzlicher O-Ring ist beim Medela Gebietsleiter erhältlich.
	<p>Wenden Sie sich an das medizinische Fachpersonal.</p>

Alarm	305			
	306			
	311			
	313			
Interner Fehler				



VORSICHT

Falls Sie kein Symbol auf dem Display erkennen können oder den Alarm auf dem Display nicht verstehen, wenden Sie sich an das medizinische Fachpersonal.

Bemerkungen/mögliche Fehlerursache	
	<p>Den Akku folgendermaßen aufladen: Entweder die Invia Liberty Pumpe in die Ladestation stellen oder das Ladegerät an den Stromanschluss an der Pumpe anschließen.</p> <p>Die verbleibende Akkulaufzeit liegt bei ca. 15 Minuten.</p>
	<p>Behälter wechseln, siehe Kapitel „Behälter wechseln“.</p>
	<p>Behälter: - Behälter entriegeln und wieder einsetzen. Schläuche: - Sicherstellen, dass die Schläuche nicht verdreht, abgeknickt oder abgeklemmt sind.</p>
	<p>Behälter wechseln, siehe Kapitel „Behälter wechseln“.</p>
	<p>Die Pumpe wieder einschalten. Wenn der interne Fehler bestehen bleibt, die Pumpe durch Drücken auf [ > 3 Sekunden] ausstellen und das medizinische Fachpersonal kontaktieren.</p>



ACHTUNG

Falls die Pumpe versagt oder nicht wieder eingeschaltet werden kann, rufen Sie sofort das medizinische Fachpersonal an.

Reinigung/Desinfektion



Die Invia Liberty Pumpe kann mit einem feuchten Tuch unter Verwendung eines milden Haushaltsreinigers abgewischt werden.

Garantie



Die Garantie gilt 2 Jahre ab Lieferdatum. Für Schäden/Folgeschäden infolge fehlerhafter Bedienung, unsachgemäßer Verwendung sowie bei Handhabung durch nicht autorisierte Personen besteht keine Haftung durch den Hersteller.

Wartung/Sicherheitskontrolle



Servicearbeiten sind nur durch autorisiertes Personal auszuführen. Die Sicherheitsprüfung ist auf die visuelle Inspektion des Gehäuses und des Ladegerätes auf Schäden beschränkt und muss vor jeder Anwendung durchgeführt werden. Wird die Invia Liberty Pumpe nur selten benutzt, muss der Akku für eine optimale Funktionsfähigkeit etwa alle 6 Monate geladen werden.

Entsorgung



Fragen Sie das medizinische Fachpersonal, wie benutzte Verbände, Behälter und Schläuche zu entsorgen sind.

Technische Daten



Lagerung des Zubehörs

Das Zubehör muss in der Verpackung aufbewahrt und bei einer Temperatur zwischen -20 °Celsius und +50 °Celsius gelagert werden.

Bedingungen für die Betriebsumgebung



Die Invia Liberty Pumpe und ihr Zubehör müssen innerhalb des Temperaturbereichs von +5 °Celsius bis +40 °Celsius betrieben werden. Benutzen Sie die Produkte nicht bei extremer Hitze oder Kälte. Vermeiden Sie hohe relative Luftfeuchtigkeit (15 - 93 % sind zulässig).



VORSICHT

Die Invia Liberty Pumpe nicht über 3000 Meter über dem Meeresspiegel verwenden.

Schutzklasse IP33

IP33

Die Invia Liberty Pumpe ist gegen das Eindringen von Fremdkörpern mit einem Durchmesser von über 2,5 mm und vor Wassertropfen geschützt.

Zeichen und Symbole



Dieses Symbol zeigt einen Hinweis (VORSICHT oder ACHTUNG) zum Gerät an.



Gerät der Schutzklasse II.



Nicht im ungetrennten Hausmüll entsorgen (gilt nur in der EU).



Dieses Symbol zeigt das Herstellungsdatum (vier Ziffern für das Jahr und zwei Ziffern für den Monat) an.



Name und Adresse des Herstellers.



Dieses Symbol zeigt an, dass das Gerät mit Ethylenoxid sterilisiert wurde.



Dieses Symbol zeigt ein rezeptpflichtiges Gerät an. VORSICHT: Nach US-Bundesgesetz darf dieses Gerät nur von Ärzten oder auf deren Anweisung verkauft werden (gilt nur für die USA).



Anwendungsteil vom Typ BF.



Dieses Symbol zeigt die Katalognummer des Herstellers an.



Seriennummer des Herstellers.



Chargennummer des Herstellers



Dieses Symbol zeigt den Schutz gegen das Eindringen von Fremdkörpern und gegen schädliche Auswirkungen infolge des Eindringens von Wasser an.



Dieses Symbol zeigt an, dass das Gerät nicht nach Ende des angegebenen Jahres und Monats verwendet werden sollte.



Dieses Symbol zeigt an, dass die Gebrauchsanweisung zu befolgen ist.



Dieses Symbol zeigt die Übereinstimmung mit zusätzlichen US-amerikanischen und kanadischen Sicherheitsvorschriften für medizinische elektrische Geräte an.



Gerät nicht verwenden, falls die Packung beschädigt ist.

pcs

Dieses Symbol zeigt die Stückzahl an.



Gleichstrombuchse.



Dieses Symbol zeigt an, dass der markierte Artikel oder das Material der Rückgewinnung von Ressourcen oder dem Recycling zugeführt wird.



Dieses Symbol zeigt die Feuchtebegrenzung für Betrieb und Lagerung an.



Dieses Symbol zeigt die Begrenzung des atmosphärischen Drucks für Betrieb und Lagerung an.



Dieses Symbol zeigt an, dass das Gerät trocken zu halten ist.



Dieses Symbol zeigt an, dass das Gerät vor Sonnenlicht zu schützen ist.



Dieses Symbol zeigt an, dass das zerbrechliche Gerät mit Vorsicht zu behandeln ist.



Dieses Symbol zeigt ein Einweggerät an. Nicht wiederverwenden.



Dieses Symbol zeigt die Temperaturbeschränkung für Betrieb, Transport und Lagerung an.



Gerät entspricht der Richtlinie 93/42/EWG über Medizinprodukte.



Dieses Symbol zeigt die richtige aufrechte Position des Transportpakets an.

Elektromagnetische Verträglichkeit (EMV)

Invia Liberty ist entsprechend den Anforderungen von IEC 60601-1-2:2007 und IEC 60601-1-2:2014 4. Fassung gemäß Abschnitt 7 und 8.9 EMV-geprüft.



ACHTUNG

Die Invia Liberty Pumpe sollte nicht verwendet werden, wenn sich andere Geräte unmittelbar neben oder auf der Pumpe befinden. Wenn der Betrieb nahe oder auf anderen Geräten erforderlich ist, dann sollte die Invia Liberty Pumpe beobachtet werden, um ihren ordnungsgemäßen Betrieb in dieser Konstellation sicherzustellen.



ACHTUNG

Benutzen Sie kein Zubehör, das nicht vom Hersteller freigegeben oder von ihm als Ersatzteil für interne Komponenten verkauft wird, da dies zu stärkeren Emissionen oder erhöhter Störanfälligkeit der Invia Liberty Pumpe führen könnte.



ACHTUNG

Elektromagnetische Verträglichkeit (EMV).

Hochfrequenz-Operationsgeräte (HF), Funknetze o. Ä. können den Betrieb des Geräts beeinträchtigen und sollten nicht in Kombination mit der Invia Liberty Pumpe betrieben werden.

Assistance

Lire l'intégralité du manuel d'instruction avant d'essayer d'utiliser le dispositif.

Pour toute question au sujet de votre dispositif médical de traitement des plaies par pression négative Invia Liberty, veuillez vous adresser à votre fournisseur/médecin au numéro ci-dessous :

COORDONNÉES
DU MÉDECIN/FOURNISSEUR :

Conservez ce mode d'emploi à l'usage du patient dans un endroit facilement accessible.

Table des matières

Avertissements, mises en garde et consignes de sécurité	60
Avertissements généraux	60
Objectif du dispositif	62
Utilisation prévue.....	62
Quand utiliser le dispositif médical (indications)	63
Quand ne pas utiliser le dispositif (contre-indications)	63
Description de l'appareil	64
Écran	65
Facteurs ayant un impact sur l'utilisation	65
Sécurité générale à domicile	66
Pendant le sommeil	67
Sous la douche, dans le bain, pendant la toilette	67
En cas de sortie	68
Installation	68
Réglage du sac de transport	70
Chargement de la batterie	70
Changer le bocal	72
Connecter/déconnecter le connecteur rapide	73
Messages d'erreur, pannes et solutions	75
Tableau des alarmes	76
Nettoyage/désinfection	80
Garantie	80
Entretien/Contrôle de sécurité	80
Élimination	80
Spécifications techniques	81
Signes et symboles	82
Compatibilité électromagnétique (EMC)	85

Avertissements, mises en garde et consignes de sécurité



AVERTISSEMENT

Indique une situation potentiellement dangereuse qui, si elle n'est pas évitée, peut entraîner la mort ou de graves blessures.



MISES EN GARDE

Indique une situation potentiellement dangereuse qui, si elle n'est pas évitée, pourrait entraîner une blessure légère ou modérée.

Avertissements généraux



AVERTISSEMENT

La personne responsable de l'utilisation quotidienne de cet appareil (patient, personnel soignant) doit pouvoir lire, comprendre et suivre les instructions fournies dans ce mode d'emploi, affichées à l'écran de la pompe et celles des professionnels de santé. Cette personne doit être capable d'entendre et de réagir à tout signal sonore.

Utiliser uniquement le dispositif médical Invia Liberty TPPN pour la personne pour laquelle il a été prescrit et uniquement pour son utilisation prévue.

Ne pas commencer le traitement sans avoir au préalable consulté le personnel et les soignants connaissant le mode d'emploi.

Le traitement doit être surveillé par un professionnel de santé.

Toute modification de cet équipement est interdite.



AVERTISSEMENT

Procéder fréquemment à un contrôle visuel du pansement et du dispositif médical Invia Liberty.

En présence de quantités importantes de sang dans le pansement, la tubulure ou le bocal :

- 1 Arrêter la pompe en appuyant sur la touche  pendant 3 secondes.
- 2 Comprimer la plaie.
- 3 Demander immédiatement une aide médicale d'urgence.

En cas de difficultés de respiration, consulter immédiatement une aide médicale d'urgence.





AVERTISSEMENT

Consulter immédiatement un professionnel de santé pour l'un des symptômes suivants :

- Perte importante de la vue ou de l'ouïe
- Douleur, irritation ou rougeur autour de la plaie
- Enflure, démangeaisons ou éruption autour de la plaie
- Fièvre
- Odeur forte émanant de la plaie
- Liquide de drainage épais vert ou modification douteuse de la couleur du liquide de drainage
- Nausées, vomissements ou diarrhée
- Gorge douloureuse et enflée
- Vertiges ou confusion
- Réactions allergiques telles que rougeur, éruption ou urticaire, enflure ou fortes démangeaisons



AVERTISSEMENT

Une fois que le professionnel de santé a réglé la pression et le mode de la pompe, ne plus appuyer sur les touches, sauf sur la touche marche/arrêt [], la touche veille [] ou la touche de mise en sourdine [].



AVERTISSEMENT

La pompe doit être utilisée 24 heures sur 24. Ne pas arrêter la pompe sauf si le professionnel de santé l'a conseillé ou en cas de saignement important.

Si la pompe est arrêtée pendant plus de 2 heures, il faut remplacer le pansement. Contacter un professionnel de santé pour lui demander de changer le pansement.



AVERTISSEMENT

Si la pompe cesse de fonctionner et qu'il est impossible de la remettre en marche, contacter immédiatement un professionnel de santé.

Objectif du dispositif

Votre professionnel de santé vous a prescrit un traitement des plaies par pression négative (TPPN).

Le traitement des plaies par pression négative a fait ses preuves en matière de guérison de différents types de plaies. La pression négative (aspiration) est exercée sur une plaie au travers d'une pompe. L'aspiration ou pression négative permet de drainer les liquides et de refermer votre plaie. Le professionnel de santé applique un pansement spécial sur la plaie et une tubulure relie la plaie au bocal de la pompe. La pompe est en marche et réglée à la pression prescrite afin de drainer le liquide de la blessure. Celui-ci est récolté dans le bocal. Le traitement est poursuivi 24 heures sur 24.

Utilisation prévue

Utilisateur

Le dispositif médical TPPN Invia Liberty est destiné à être utilisé par des professionnels de santé ou par des non professionnels formés de manière adéquate.

Les professionnels de santé doivent expliquer aux utilisateurs débutants le mode d'emploi destiné au patient, ainsi que toutes les informations permettant d'utiliser la pompe en toute sécurité.

Patients ciblés

Le dispositif médical TPPN Invia Liberty est uniquement destiné à être utilisé sur des patients adultes présentant les affections décrites dans le mode d'emploi. Cet appareil n'a pas été étudié sur des patients de pédiatrie.

Environnement prévu

Le dispositif médical TPPN Invia Liberty est destiné à être utilisé dans le cadre de soins de longue durée, à l'hôpital et à domicile.

Quand utiliser le dispositif médical (indications)

Le dispositif médical de traitement des plaies par pression négative (TPPN) Invia Liberty est préconisé aux patients pouvant bénéficier d'un appareil d'aspiration (traitement des plaies par pression négative), car celui-ci favorise la guérison des plaies en seconde ou troisième intention (première différée). Il prépare le lit de la plaie pour que celle-ci puisse se refermer, en réduisant l'œdème, en favorisant la formation du tissu de granulation et l'irrigation, ainsi que l'élimination des exsudats et des éléments infectieux. Lorsqu'il est utilisé sur ces incisions chirurgicales refermées, le dispositif médical TPPN Invia Liberty est également conçu pour prendre en charge la zone entourant les incisions chirurgicales qui continue à être drainée suite à la fermeture par points de suture ou par agrafe, tout en assurant sa fermeture et en éliminant les exsudats via la mise en pratique du traitement des plaies par pression négative.

Il convient d'utiliser le dispositif médical TPPN Invia Liberty dans les cas suivants :

- Plaies aiguës ou subaiguës
- Plaies chroniques
- Plaies déhiscentes
- Ulcères ischémiques
- Ulcères diabétiques/neuropathiques
- Ulcères veineux
- Plaies traumatiques
- Brûlures au second degré
- Lambeaux et greffes
- Incisions chirurgicales fermées

Quand ne pas utiliser le dispositif (contre-indications)

Le dispositif médical TPPN Invia Liberty est contre-indiqué en présence de :

- Tissus nécrosés avec présence d'escarres
- Ostéomyélite non traitée
- Fistules non-entériques et inexplorées
- Présence de tumeur maligne dans la plaie
- Vaisseaux sanguins exposés
- Nerfs exposés
- Site anastomotique exposé de vaisseaux sanguins ou de dérivations
- Organes exposés

En cas de questions, consulter un professionnel de santé.

Description de l'appareil

Vérifier que le contenu du carton du dispositif médical Invia Liberty est complet et en bon état.



AVERTISSEMENT

Ne pas utiliser d'accessoires autres que ceux décrits ci-dessous.

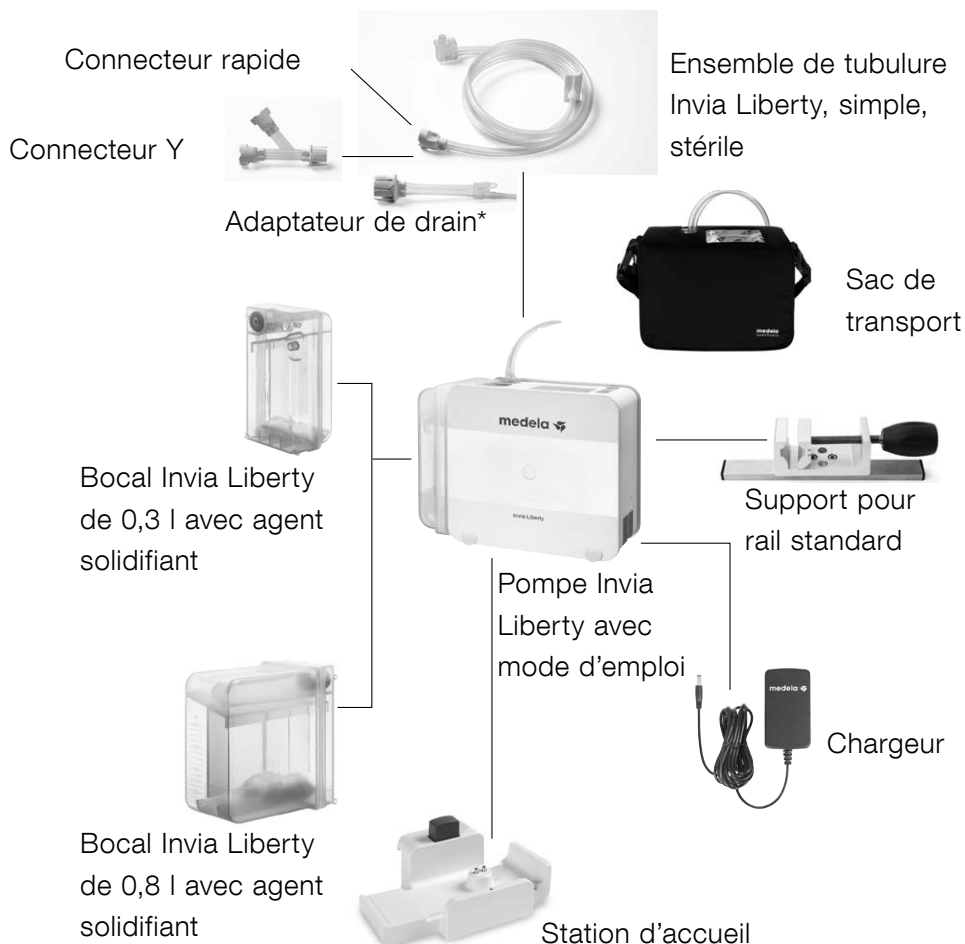

*Disponibilité du produit limitée à certains pays.

Écran

Touches de fonctionnement de la pompe Invia Liberty

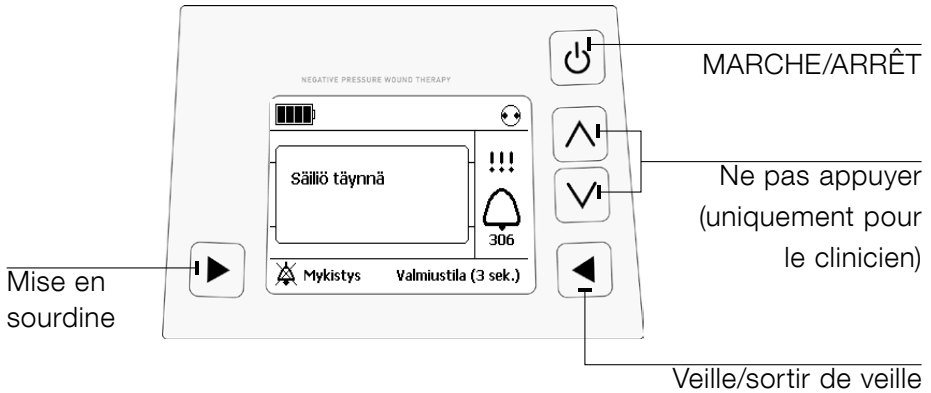

Facteurs ayant un impact sur l'utilisation



MISE EN GARDE

Pendant son utilisation, la pompe Invia Liberty doit être en position verticale.



Sécurité générale à domicile



Veillez lire et respecter ces avertissements et consignes de sécurité avant toute mise en service. Ce mode d'emploi doit être conservé avec l'appareil. Ce document sert de directive générale pour l'utilisation du produit. Les problèmes médicaux doivent être traités par un médecin.



MISES EN GARDE/AVERTISSEMENTS

- Ne pas utiliser de rallonges avec la pompe Invia Liberty.
- Placer le câble d'alimentation de manière à ce que personne ne trébuche et tombe.
- Ne jamais placer le câble d'alimentation autour du cou.
- Éloigner le câble d'alimentation des surfaces chaudes.
- Ne pas débrancher le câble d'alimentation de la prise murale en tirant sur le câble.
- Ne pas essayer de remettre en état ou de réparer la pompe Invia Liberty. Consulter un professionnel la santé si la pompe ne fonctionne pas.
- Maintenir la pompe Invia Liberty propre et sèche.
- Ne jamais placer la pompe Invia Liberty dans de l'eau ou d'autres liquides.
- Si la pompe Invia Liberty est mouillée, la sécher à l'aide d'un linge sec.
- Ne pas sécher la pompe Invia Liberty dans un four à micro-ondes.
- Tenir les enfants et les animaux domestiques éloignés de la pompe Invia Liberty.
- Une surveillance est nécessaire si la pompe Invia Liberty est utilisée à proximité d'enfants.
- Tenir la pompe Invia Liberty éloignée de la lumière directe du soleil.
- Risque d'explosion : la pompe Invia Liberty n'est pas conçue pour fonctionner dans des environnements présentant des risques d'explosion, comme ceux enrichis en oxygène ou en présence d'anesthésiques inflammables.
- Les appareils de communication sans fil tels que les appareils domestiques sans fil en réseau, les téléphones portables, les téléphones sans fil et leur base ou les talkies-walkies peuvent perturber la pompe Invia Liberty et doivent en être éloignés d'au

moins 30 cm. empêchant la batterie de se recharger suffisamment, ce qui peut entraîner une erreur interne. Voir le chapitre Messages et résolution de problèmes pour connaître la marche à suivre en cas d'erreur interne.

- Ce produit contient des piles lithium-ion qui entraînent un risque d'incendie, d'explosion et de brûlures. Ce produit ne doit pas être démonté, écrasé, chauffé au-delà de 100 °C, incinéré ou enflammé.

Si le niveau de vide change ou qu'une erreur se produit, éloigner la pompe Invia Liberty d'au moins 30 cm du téléphone portable lors de l'émission ou de la réception d'un appel. Arrêter puis remettre en marche la pompe Invia Liberty afin de la réinitialiser après qu'une erreur s'est produite. Respecter, autant que possible, une distance de sécurité d'au moins 30 cm entre la pompe Invia Liberty et le téléphone portable.

Pendant le sommeil



- S'assurer que la tubulure de la pompe Invia Liberty n'est pas emmêlée.
- Prévenir la chute de la pompe Invia Liberty pendant le sommeil.
- Toujours recharger la pompe Invia Liberty au coucher.

Sous la douche, dans le bain, pendant la toilette



- Ne pas utiliser la pompe Invia Liberty dans le bain ou sous la douche.
- Il est possible de débrancher brièvement (20 minutes max.) la pompe Invia Liberty du pansement pour se changer ou faire sa toilette. Pour savoir comment prendre un bain, consulter un professionnel de santé.
- Ne pas mouiller la pompe Invia Liberty.
- Ne pas déposer la pompe Invia Liberty à un endroit où elle risque de tomber dans une douche, un évier ou une baignoire.
- Ne pas toucher la pompe Invia Liberty si elle est tombée à l'eau. Débrancher immédiatement l'appareil de la prise électrique et détacher la pompe du pansement.

En cas de sortie



- Vérifier l'état de la batterie et, le cas échéant, recharger la batterie avant de quitter le domicile.
- Pour un meilleur confort, placer la pompe Invia Liberty dans le sac de transport.
- Penser à emporter un bocal et un cordon d'alimentation.

Installation



AVERTISSEMENT

Vérifier le pansement fréquemment, pour vérifier que la pompe Invia Liberty fonctionne. Observer le pansement, la zone proche de la plaie et le liquide présent dans le bocal pour voir s'ils présentent des signes d'infection ou d'autres complications tels que décrits par le professionnel de santé.

Mise en marche

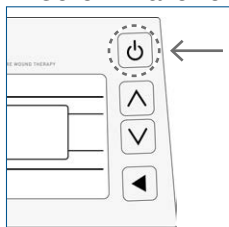

Mettre la pompe Invia Liberty en marche en appuyant sur [].

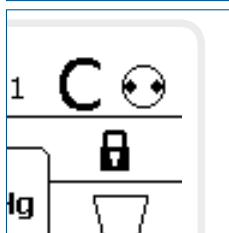

Vue de l'écran lorsque la pompe fonctionne. L'indicateur de fonctionnement/veille tourne [].

**AVERTISSEMENT**

Ne pas essayer de suivre ce traitement sans être suivi par un professionnel de santé.

**AVERTISSEMENT**

La pompe TPPN doit fonctionner 24 heures sur 24. Ne pas interrompre le traitement sauf sur ordre du professionnel de santé ou en cas de saignement excessif.

**AVERTISSEMENT**

Faire remplacer le pansement par un professionnel de santé et recommencer le traitement s'il a été interrompu pendant plus de 2 heures.

**AVERTISSEMENT**

La pompe Invia Liberty ne détecte pas les obstructions de la tubulure connectée à l'adaptateur de drain ou connectée au bras courbé du connecteur Y. Vérifier la tubulure connectée du pansement à l'adaptateur de drain ou au bras courbé du connecteur Y fréquemment pendant la journée afin de s'assurer qu'elle n'est ni tordue ni obstruée.

En cas d'obstruction dans la tubulure connectée à l'adaptateur de drain ou dans la tubulure connectée au bras courbé du connecteur Y, contacter un professionnel de santé.

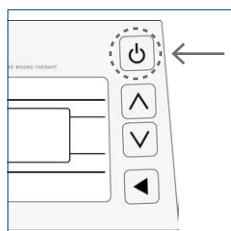
**Arrêt**

Arrêter la pompe Invia Liberty en appuyant sur [] pendant 3 secondes. Appuyer une seule fois.

Réglage du sac de transport

La pompe Invia Liberty est destinée à être portée dans un sac de transport pendant l'utilisation.



- 1 Ouvrir le sac de transport.
- 2 Glisser la pompe Invia Liberty dans la poche prévue à cet effet.
- 3 Sécuriser la pompe à l'aide de la fermeture autoagrippante.

La bandoulière peut aussi être utilisée comme une ceinture. Pour ce faire, détacher la bandoulière des côtés du sac de transport et la faire glisser dans les deux boucles situées à l'arrière du sac de transport.

Chargement de la batterie

Lorsque la batterie est complètement chargée, sa durée de fonctionnement dépasse généralement 14 heures. Si la pompe Invia Liberty fonctionne en continu en raison d'une fuite d'air, il est possible que la batterie doive être rechargée plus tôt.

Symboles relatifs à l'état de la batterie



chargée / à moitié chargée / déchargée (vide)

Si la batterie est complètement déchargée (vide), suivre les consignes ci-dessous.

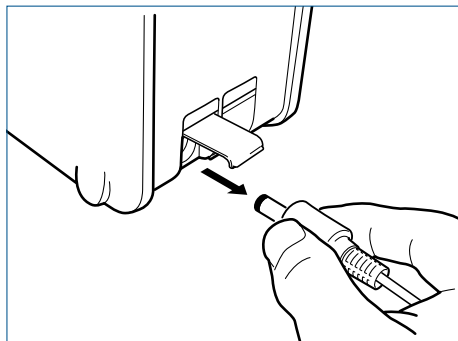

Ouvrir l'orifice de l'adaptateur secteur. Brancher la pompe Invia Liberty sur la fiche électrique venant du bloc d'alimentation fourni avec la pompe. Brancher le cordon à l'autre extrémité du bloc d'alimentation à une prise murale. Les barres figurant sur l'écran de la batterie bougent pour indiquer que l'appareil est en charge.

La batterie est complètement chargée au bout de 4 heures environ. Lorsque la batterie est complètement chargée et que la pompe reste connectée au bloc d'alimentation,  est affiché en permanence à l'écran. Une fois le chargement terminé, débrancher le bloc d'alimentation du mur et débrancher la pompe Invia Liberty du bloc d'alimentation.

Fermer l'orifice de l'adaptateur secteur en appuyant sur le couvercle de protection.



MISE EN GARDE

Poursuivre le traitement TPPN pendant que la batterie de la pompe est en charge. Ne pas désactiver la pompe lorsque la batterie est en cours de chargement.

Toujours charger la batterie pendant la nuit.

Adaptateur secteur

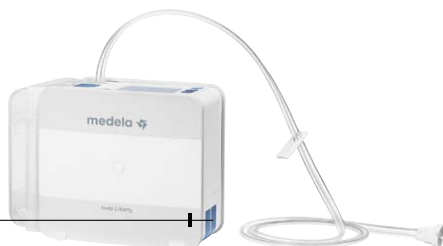

Changer le bocal

Remplacer le bocal au moins une fois par semaine ou lorsque le bocal est visiblement plein ou que l'alarme indiquant qu'il est plein retentit, en suivant les consignes affichées à l'écran.

1 Se laver les mains.

2 Appuyer sur la touche « Veille » [ > 3 secondes] pour couper le moteur de la pompe.

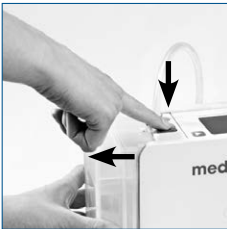
3  Appuyer sur la touche de déverrouillage au sommet de la pompe et retirer le bocal.

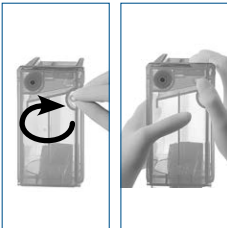
4  Fermer hermétiquement le bocal usagé avec le couvercle situé sur le côté du bocal.

5  Déballer le nouveau bocal et le positionner dans les rainures situées à la base de la pompe. Pousser le bocal vers le haut et l'emboîter dans la pompe Invia Liberty.



MISE EN GARDE

Ne pas utiliser un bocal Invia Liberty dont l'emballage stérile a été endommagé.

6



Mettre la pompe Invia Liberty en marche en appuyant sur la touche [] pour reprendre le traitement et glisser la pompe dans le sac de transport.

- 7 Éliminer le bocal usagé conformément aux consignes du professionnel de santé.

Connecter / déconnecter le connecteur rapide

Il est possible de débrancher le connecteur rapide brièvement (jusqu'à 20 minutes) pour se changer ou faire sa toilette. Pendant ce temps, la pompe peut passer au mode « Veille » pendant une période de 5 minutes, après quoi l'alarme « Mode Veille » s'enclenchera. Celle-ci peut être mise en sourdine pendant 5 minutes supplémentaires.

- 1 Se laver les mains.
- 2 Fermer le clamp de la tubulure du bocal et fermer le clamp de la tubulure associée au pansement.
- 3 Appuyer sur la touche « Veille » [ > 3 secondes] pour couper le moteur de la pompe.



- 4 Débrancher la tubulure du connecteur rapide en appuyant sous les côtés du connecteur.

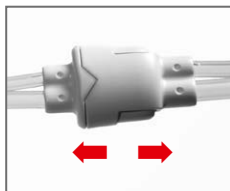
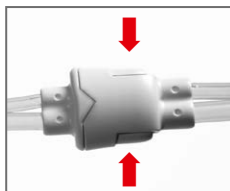

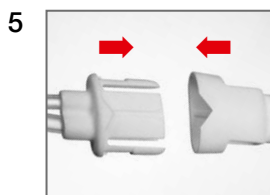

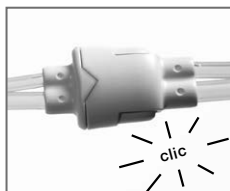

Pour rebrancher le connecteur rapide, relier les deux sections jusqu'à entendre un déclic.

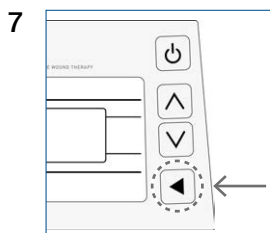

Ouvrir le clamp de la tubulure du bocal et ouvrir le clamp de la tubulure associée au pansement.



Appuyer sur « Marche » [] pour reprendre le traitement.

Messages d'erreur, pannes et solutions



Ne pas paniquer si un signal sonore retentit.
Suivre les instructions ci-dessous.

- 1 Si la pompe Invia Liberty se trouve dans le sac de transport, ouvrir son couvercle.
- 2 Appuyer sur la touche [] pour mettre le signal sonore en sourdine pendant 60 secondes (il est possible d'appuyer sur la touche à chaque fois que le signal retentit).



Tableau des alarmes

Avertissement	401	<p>Batterie faible</p> <p>Muet Mode veille (3 sec.)</p>	<p>Charger la batterie</p> <p>Muet Mode veille (3 sec.)</p>
	405	<p>Mode veille</p> <p>Muet Marche</p>	<p>Mettre la pompe en marche ou l'arrêter</p> <p>Muet Marche</p>
	406	<p>Température interne élevée</p> <p>Muet Mode veille (3 sec.)</p>	 <p>Éloignez la pompe de la source de chaleur (p. ex. lumière directe du soleil) ou retirez tous les éléments couvrants (p. ex. couverture).</p> <p>Muet Mode veille (3 sec.)</p>
Alarme	301	<p>Fuite d'air dans le système</p> <p>Muet Mode veille (3 sec.)</p>	 <p>Rechercher d'éventuelles fuites d'air au niveau du pensement et de l'insertion du bocal.</p> <p>Consulter le mode d'emploi pour plus d'instructions.</p> <p>Muet Mode veille (3 sec.)</p>
	302	<p>Le système est obstrué</p> <p>Muet Mode veille (3 sec.)</p>	 <p>Vérifiez que le tuyau est bien dégagé et n'est pas tordu. Vérifiez que le réservoir est plein.</p> <p>Reportez-vous au mode d'emploi pour plus d'instructions.</p> <p>Muet Mode veille (3 sec.)</p>

Remarques / causes potentielles de l'erreur	
	<p>Rechargez la batterie soit en plaçant la pompe Invia Liberty sur la station d'accueil soit en branchant le chargeur sur l'adaptateur secteur de la pompe.</p> <p>La durée de charge restante de la batterie est d'environ 30 minutes.</p>
	<p>Si la pompe reste en mode Veille pendant plus de 5 minutes, une alarme se déclenche.</p> <p>Pour continuer la thérapie, appuyer sur « Marche » [▶].</p>
	<p>Laisser refroidir la pompe Invia Liberty selon les instructions à l'écran.</p>
	<p>Pansement :</p> <ul style="list-style-type: none"> - Vérifier la présence d'une fuite d'air au niveau du pansement. Appuyez fermement sur les bords du pansement, autour de la tubulure de drainage ou sur le FitPad Invia. - Appliquer davantage de pansements en film pour fermer hermétiquement la zone où s'est produite la fuite. <p>Raccords :</p> <ul style="list-style-type: none"> - Raccorder correctement la tubulure branchée sur le pansement à la tubulure du bocal. - Veiller à ce que la tubulure du bocal soit insérée droit dans la pompe. <p>Bocal :</p> <ul style="list-style-type: none"> - Veiller à insérer le bocal correctement, le déverrouiller et le repositionner. - Veiller à ce que le joint torique orange placé à côté de la tubulure du bocal sur la pompe soit bien présent. Un joint torique supplémentaire est disponible via le représentant Medela.
	<p>Appelez votre professionnel de santé.</p>

Alarme	305	<p>batterie vide</p> <p>Muet</p> <p>305</p>	<p>Charger la batterie</p>
	306	<p>Bocal plein</p> <p>Muet</p> <p>Mode veille (3 sec.)</p> <p>306</p>	<p>Changer le bocal</p> <p>Mode veille (3 sec.)</p>
	311	<p>Echec de l'autotest</p> <p>Muet</p> <p>311</p>	<p>Libérer puis réendecher le bocal</p> <p>Marche</p>
	313	<p>Filtre bouché</p> <p>Muet</p> <p>Marche</p> <p>313</p>	<p>Changer le bocal</p> <p>Marche</p>
Erreur interne	<p>Erreur interne</p> <p>Muet</p>	<p>Redémarrez la pompe.</p> <p>Si le problème persiste, veuillez contacter votre représentant Health Care.</p>	

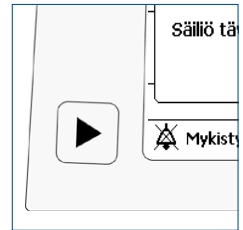
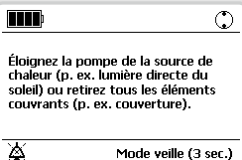
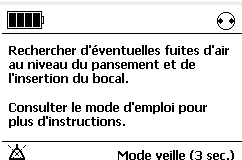
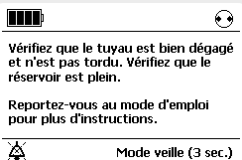

MISE EN GARDE

S'il est impossible d'identifier un symbole ou de comprendre l'alerte sur l'écran, contacter un professionnel de santé.

Remarques / causes potentielles de l'erreur	
	<p>Rechargez la batterie soit en plaçant la pompe Invia Liberty sur la station d'accueil soit en branchant le chargeur sur l'adaptateur secteur de la pompe.</p> <p>La durée de charge restante de la batterie est d'environ 15 minutes.</p>
	<p>Remplacer le bocal (voir le chapitre « Remplacer le bocal »).</p>
	<p>Bocal : - Déverrouiller le bocal et le replacer. Tubulure : - Veiller à ce que la tubulure ne soit pas coudée, tordue ou bloquée.</p>
	<p>Remplacer le bocal (voir le chapitre « Remplacer le bocal »).</p>
	<p>Redémarrez la pompe. Si l'erreur interne persiste, arrêtez la pompe en appuyant sur [ > 3 secondes] et contactez un professionnel de santé.</p>



AVERTISSEMENT

Si la pompe présente un dysfonctionnement ou ne se met pas en marche, appeler immédiatement un professionnel de santé.

Nettoyage/désinfection

Il est possible de nettoyer la pompe Invia Liberty à l'aide d'un chiffon humide imprégné d'un détergent doux.



Garantie

La garantie est de 2 ans après la date de livraison. Le fabricant décline toute responsabilité en cas de dégâts causés ou résultant d'une manipulation non conforme, d'une utilisation inappropriée ou d'une manipulation par des personnes non autorisées.



Entretien/Contrôle de sécurité

La maintenance ne peut être effectuée que par les personnes autorisées. Un contrôle de sécurité se limite à l'inspection visuelle du boîtier et du chargeur pour s'assurer qu'ils ne sont pas endommagés. Il doit être effectué avant toute utilisation. Si la pompe Invia Liberty n'a pas été utilisée, la batterie doit en moyenne être chargée tous les 6 mois afin de garantir un fonctionnement optimal.



Élimination

Demander à un professionnel de santé comment éliminer les pansements, bouches et tubulures usagés.



Spécifications techniques



Conditions d'entreposage des accessoires

Les accessoires doivent rester dans leur emballage et être entreposés à des températures comprises entre -20 °C et +50 °C.

Environnement de fonctionnement



La pompe Invia Liberty et ses accessoires doivent être utilisés à des températures se situant entre +5 °C et +40 °C.

Ne pas utiliser les produits en cas de froid ou de chaleur extrêmes.

Éviter l'humidité relative élevée (tolérance entre 15 et 93 %).



MISE EN GARDE

Ne pas utiliser la pompe Invia Liberty au-delà de 3 000 mètres d'altitude.

Classe de protection IP33

IP33

La pompe Invia Liberty est protégée contre la pénétration de gouttes d'eau et de substances solides de dimensions supérieures à 2,5 millimètres.

Signes et symboles



Ce symbole correspond à une MISE EN GARDE ou un AVERTISSEMENT associé(e) au dispositif.



Ce symbole indique un appareil de classe II.



Ne pas jeter l'appareil avec les déchets municipaux non triés (uniquement pour l'UE).



Ce symbole indique la date de fabrication de l'appareil (quatre chiffres pour l'année et deux chiffres pour le mois).



Ce symbole indique le nom et l'adresse du fabricant.

STERILEEO

Ce symbole signifie que l'appareil a été stérilisé avec de l'oxyde d'éthylène.

R_xonly

Ce symbole indique un dispositif sur prescription. MISE EN GARDE : La loi fédérale américaine limite la vente de ce dispositif à un médecin ou sur l'ordre d'un médecin (É.-U. uniquement).



Ce symbole indique l'application d'une pièce de type BF.

REF

Ce symbole indique le numéro de catalogue du fabricant.

SN

Ce symbole indique le numéro de série du fabricant.

LOT

Ce symbole indique le code de lot du fabricant.

IP33

Ce symbole indique une protection contre les effets nocifs de l'introduction d'objets étrangers solides et de gouttes d'eau.



Ce symbole indique que l'appareil ne doit pas être utilisé après la fin du mois et de l'année mentionnés.



Ce symbole indique qu'il convient de suivre le mode d'emploi.



Ce symbole signifie que l'appareil est conforme aux normes de sécurité établies par les États-Unis et le Canada pour les appareils électromédicaux.



Ce symbole indique que l'appareil ne doit pas être utilisé si l'emballage est endommagé.

pcs

Ce symbole indique le nombre d'articles.



Ce symbole signifie que l'élément marqué ou sa matière est intégré à un processus de récupération/recyclage.



Ce symbole correspond au taux d'humidité maximal à prendre en compte pour l'utilisation et le stockage de l'appareil.



Ce symbole indique la limite de pression atmosphérique à prendre en compte pour l'utilisation et le stockage de l'appareil.



Ce symbole indique que l'appareil doit être maintenu au sec.



Ce symbole indique que le dispositif doit être conservé à l'abri de la lumière du soleil.



Ce symbole indique une prise de courant continu.



Ce symbole indique un dispositif à usage unique. Ne réutilisez pas celui-ci.



Ce symbole indique la limite de température pour l'utilisation, le transport et le stockage de l'appareil.



Ce symbole indique que l'appareil est fragile et doit être manipulé avec précaution.



Ce symbole indique que l'appareil est conforme à la directive 93/42/CEE relative aux dispositifs médicaux.



Ce symbole indique que le carton de transport doit être en position verticale pour être transporté correctement.

Compatibilité électromagnétique (EMC)

La pompe Invia Liberty fait l'objet de tests CEM en conformité avec les normes IEC 60601-1-2:2007 et IEC 60601-1-2:2014 4^e édition conformément aux clauses 7 et 8.9.



AVERTISSEMENT

La pompe Invia Liberty ne doit pas être utilisée ni entreposée avec d'autres appareils. S'il est impossible de faire autrement, il faut surveiller la pompe Invia Liberty afin de s'assurer qu'elle fonctionne correctement dans la configuration choisie.



AVERTISSEMENT

Ne pas utiliser d'autres accessoires que ceux spécifiés ou vendus par le fabricant pour remplacer des composants internes, sous peine d'entraîner une augmentation des émissions ou une diminution de l'immunité de la pompe Invia Liberty.



AVERTISSEMENT

EMC

Les équipements chirurgicaux à HF (haute fréquence), les réseaux de radio ou similaires peuvent avoir une influence sur le fonctionnement du dispositif et ne doivent pas être utilisés en même temps que la pompe Invia Liberty.

Ayuda

Lea el manual de instrucciones en su totalidad antes de empezar a utilizar este dispositivo.

Si tiene alguna pregunta sobre el sistema de tratamiento de heridas con presión negativa Invia Liberty, póngase en contacto con su médico o profesional sanitario en el siguiente número:

INFORMACIÓN DE CONTACTO DEL MÉDICO/
PROFESIONAL SANITARIO:

Conserve estas instrucciones de uso (IDU) para el paciente en un lugar de fácil acceso.

Índice

Advertencias, precauciones e instrucciones de seguridad	88
Advertencias generales	88
Finalidad de este dispositivo	90
Uso previsto	90
Cuándo se debe utilizar el dispositivo (indicaciones de uso)	91
Cuándo no se debe utilizar el dispositivo (contraindicaciones)	91
Descripción del dispositivo	92
Pantalla	93
Condiciones que afectan al uso	93
Seguridad general en el hogar	94
Al dormir	95
Al ducharse, bañarse o lavarse	95
Al salir de casa	96
Instrucciones de configuración	96
Ajuste del maletín de transporte	98
Carga de la batería	98
Cambio del recipiente	100
Conexión y desconexión del conector rápido	101
Notificaciones y resolución de problemas	103
Tabla de alarmas	104
Limpieza y desinfección	108
Garantía	108
Mantenimiento y control de seguridad	108
Eliminación	108
Especificaciones técnicas	109
Signos y símbolos	110
Compatibilidad electromagnética (CEM)	113

Advertencias, precauciones e instrucciones de seguridad



ADVERTENCIA

Indica una situación potencialmente peligrosa que, de no evitarse, puede ocasionar lesiones graves o incluso la muerte.



PRECAUCIONES

Indica una situación potencialmente peligrosa que, de no evitarse, puede ocasionar lesiones leves o moderadas.

Advertencias generales



ADVERTENCIA

La persona encargada de utilizar este dispositivo a diario (paciente o cuidador) deberá ser capaz de leer, comprender y seguir las instrucciones suministradas por este manual de uso, por la pantalla del aspirador y por el profesional sanitario. Dicha persona debe poder escuchar y reaccionar a señales acústicas.

Utilice el sistema NPWT Invia Liberty únicamente con la persona a quien se ha prescrito y solo para el uso previsto.

No aplique el tratamiento sin la supervisión de un profesional sanitario y sin consultar primero al personal sanitario y de enfermería capacitado sobre las instrucciones de uso del mismo.

No está permitido realizar modificaciones en el equipo.



ADVERTENCIA

Compruebe visualmente el apósito de la herida y el sistema Invia Liberty de manera frecuente.

Si observa una gran cantidad de sangre en el apósito, en los tubos o en el recipiente:

- 1 Apague el aspirador pulsando  durante 3 segundos.
- 2 Aplique presión sobre la herida.
- 3 Busque inmediatamente asistencia médica de emergencia.



Si tiene dificultades para respirar, busque inmediatamente asistencia médica de emergencia.

**ADVERTENCIA**

Póngase de inmediato en contacto con su profesional sanitario si presenta los siguientes síntomas:

- pérdida significativa de la visión o la audición;
- dolor, molestia o enrojecimiento en la zona circundante a la herida;
- hinchazón, comezón o sarpullidos alrededor de la herida;
- fiebre;
- olor fuerte procedente de la herida;
- drenaje verde y espeso o cualquier cambio en el color del drenaje;
- náuseas, vómitos o diarrea;
- dolor de garganta con inflamación;
- mareos o confusión;
- reacciones alérgicas, como enrojecimiento, sarpullidos o urticaria, hinchazón o comezón graves.

**ADVERTENCIA**

Una vez que el profesional sanitario haya ajustado la configuración de presión y modalidad del aspirador, no pulse ningún otro botón que no sea el botón de encendido/apagado [], el botón de espera [] o el botón de silencio [].

**ADVERTENCIA**

El aspirador debe utilizarse las 24 horas del día. No detenga el aspirador a menos que así lo indique el profesional sanitario o que se produzca un sangrado excesivo.

Si el aspirador se detiene durante más de dos horas, deberá cambiarse el apósito. Diríjase a su profesional sanitario para solicitar un cambio del apósito.

**ADVERTENCIA**

Si el aspirador deja de funcionar y no es posible encenderlo, llame inmediatamente a su profesional sanitario.

Finalidad de este dispositivo

Su profesional sanitario le ha prescrito el tratamiento de heridas con presión negativa (NPWT).

Se ha demostrado que el tratamiento de heridas con presión negativa estimula la curación de toda una serie de tipos de heridas. La presión negativa (succión) se proporciona a una herida a través de un aspirador. La succión o presión negativa le ayudará a retirar los fluidos y cerrar su herida. Su profesional sanitario colocará un apósito especial sobre su herida y un tubo que irá desde la herida hasta el recipiente situado en el aspirador. A continuación, se enciende el aspirador a la presión prescrita para retirar las secreciones de su herida y estas pasan al recipiente. El tratamiento se aplicará las 24 horas del día.

Uso previsto

Usuario previsto

El sistema NPWT Invia Liberty está diseñado para ser utilizado por profesionales sanitarios o usuarios con la formación adecuada. Los profesionales sanitarios son responsables de capacitar a los usuarios no profesionales según las instrucciones de uso para pacientes y de explicarles toda la información relacionada con la seguridad.

Población de pacientes prevista

El sistema NPWT Invia Liberty se ha concebido únicamente para su uso en pacientes que muestren las afecciones descritas en las indicaciones de uso. No se ha estudiado el uso del dispositivo en pacientes pediátricos.

Entorno previsto

El sistema NPWT Invia Liberty está diseñado para ser utilizado en hospitales, así como en centros de cuidados prolongados y en asistencia domiciliaria.

Cuándo se debe utilizar el dispositivo

(indicaciones de uso)

El sistema de tratamiento de heridas con presión negativa (NPWT) Invia Liberty está indicado para pacientes que pueden beneficiarse del uso de un dispositivo de succión (NPWT), ya que crea unas condiciones que contribuyen a la cicatrización de heridas por segunda o tercera intención (cicatrización primaria retardada) al preparar el lecho de la herida para su cierre, reducir el edema, fomentar la formación y perfusión de tejido de granulación, y eliminar el exudado y el material infeccioso.

Cuando se utiliza en incisiones quirúrgicas cerradas, el sistema NPWT Invia Liberty también está indicado para tratar el entorno de aquellas incisiones quirúrgicas que siguen drenando tras un cierre suturado o grapado, al mantener el entorno cerrado y eliminar el exudado mediante la aplicación del tratamiento de heridas con presión negativa.

El sistema NPWT Invia Liberty es adecuado para los siguientes casos:

- Heridas agudas o subagudas
- Heridas crónicas
- Heridas dehiscentes
- Úlceras por presión
- Úlceras diabéticas o neuropáticas
- Úlceras por insuficiencia venosa
- Heridas traumáticas
- Quemaduras de espesor parcial
- Colgajos e injertos
- Incisiones quirúrgicas cerradas

Cuándo no se debe utilizar el dispositivo

(contraindicaciones)

El sistema NPWT Invia Liberty está contraindicado en los siguientes casos:

- Tejido necrótico con presencia de escaras
- Osteomielitis no tratada
- Fístulas no entéricas e inexploradas
- Heridas neoplásicas
- Vasculatura expuesta
- Nervios expuestos
- Anastomosis expuesta en los vasos sanguíneos o derivaciones
- Órganos expuestos

Si tiene cualquier duda, consulte a su profesional sanitario.

Descripción del dispositivo

Revise el embalaje de entrega del sistema Invia Liberty para comprobar que esté completo y en buenas condiciones.



ADVERTENCIA

No utilice accesorios que no sean los que se describen a continuación.



* Producto no disponible en todos los países

Pantalla

Botones para manejar el aspirador Invia Liberty

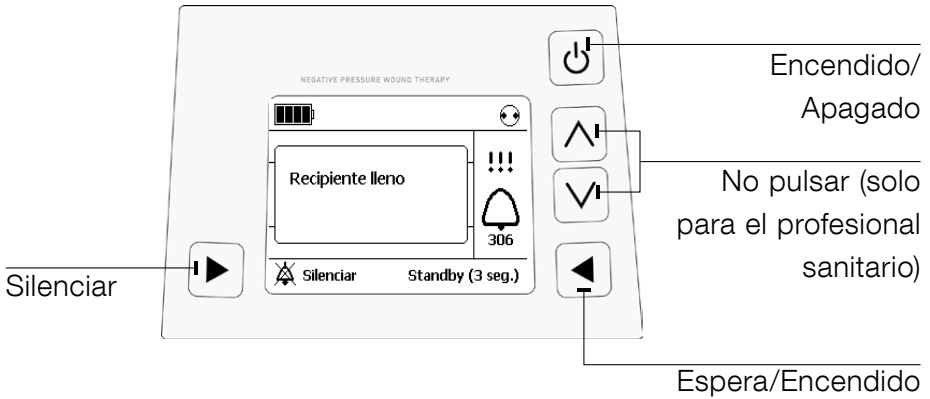

Condiciones que afectan al uso



PRECAUCIÓN

El aspirador Invia Liberty debe permanecer en posición vertical durante su uso.





Lea y tenga en cuenta estas advertencias e instrucciones de seguridad antes de comenzar a utilizar el sistema. Estas instrucciones de uso deben guardarse con el dispositivo. Tenga en cuenta que estas instrucciones de uso son pautas generales para la utilización del producto. Para resolver situaciones médicas, deberá consultar a un médico.



PRECAUCIONES/ADVERTENCIAS

- No utilice alargadores eléctricos con el aspirador Invia Liberty.
- Coloque el cable de alimentación de forma que no pueda ocasionar tropiezos o caídas.
- Nunca coloque el cable de alimentación alrededor de su cuello.
- Evite que el cable de alimentación entre en contacto con superficies calientes.
- No tire del cable de alimentación para desenchufarlo de la pared.
- No intente reparar usted mismo el aspirador Invia Liberty. Si no funciona, póngase en contacto con su profesional sanitario.
- Mantenga el aspirador Invia Liberty limpio y seco.
- Nunca sumerja el aspirador Invia Liberty en agua u otros líquidos.
- En caso de que el aspirador se moje, séquelo con una toalla.
- No seque el aspirador Invia Liberty en el microondas.
- Mantenga el aspirador fuera del alcance de niños y mascotas.
- Se requiere supervisión cuando el aspirador Invia Liberty se utiliza cerca de niños.
- No exponga el aspirador Invia Liberty a la luz solar directa.
- Riesgo de explosión: el aspirador Invia Liberty no se debe usar en entornos potencialmente explosivos, incluidos aquellos enriquecidos con oxígeno y áreas con anestésicos inflamables.
- El uso de equipos de comunicación inalámbrica, como dispositivos domésticos de red inalámbrica, teléfonos móviles, teléfonos inalámbricos y sus soportes, y walkie-talkies, puede afectar al aspirador Invia Liberty, por lo que se deben mantener a una distancia mínima de 30 cm del aspirador Invia Liberty. Esto puede ocasionar una carga insuficiente de la batería o generar un fallo

interno. Consulte el capítulo «Notificaciones y resolución de problemas» para saber qué hacer en caso de fallo interno.

- Este producto contiene baterías de iones de litio que pueden acarrear riesgo de incendio, explosión y quemaduras. Evite desmontarlo, golpearlo, calentarlo a una temperatura superior a 100 °C, incinerarlo o quemarlo.

Si detecta un cambio del nivel de vacío o algún otro error, coloque el aspirador Invia Liberty a una distancia de al menos 30 cm de cualquier teléfono móvil que esté emitiendo o recibiendo llamadas. Apague y encienda nuevamente el aspirador Invia Liberty para reajustarlo después de un error. Siempre que sea posible, se recomienda mantener una distancia de seguridad mínima de 30 cm entre el aspirador Invia Liberty y cualquier teléfono móvil.

Al dormir



- Asegúrese de que los tubos del Invia Liberty no puedan doblarse.
- Evite que el aspirador pueda caer al suelo mientras duerme.
- Cargue siempre el aspirador Invia Liberty cuando se vaya a la cama.

Al ducharse, bañarse o lavarse



- No utilice el aspirador Invia Liberty mientras se baña o se ducha.
- El Invia Liberty puede desconectarse del apósito durante un lapso de tiempo corto (de hasta 20 minutos) para cambiarse de ropa o para asearse. Analice los planes de aseo con su profesional sanitario.
- Evite que el aspirador Invia Liberty se moje.
- No coloque el aspirador Invia Liberty en un lugar desde el cual se pueda caer a una ducha, a un lavabo o una bañera.
- No toque el Invia Liberty si se ha caído al agua. Desconecte el dispositivo inmediatamente de la corriente eléctrica y desconecte el aspirador del apósito.

Al salir de casa



- Compruebe el estado de la batería y, si es necesario, recárguela antes de salir de casa.
- Para mayor comodidad, coloque el aspirador Invia Liberty en su maletín de transporte.
- No se olvide de llevar consigo una fuente de alimentación y un recipiente extra.

Instrucciones de configuración



ADVERTENCIA

Compruebe con frecuencia el aspirador Invia Liberty y el apósito para asegurarse de que funcione. Compruebe visualmente el apósito de la herida, el área circundante y el fluido del recipiente para buscar indicios de infección u otras complicaciones, según lo que le indique su profesional sanitario.

Encendido

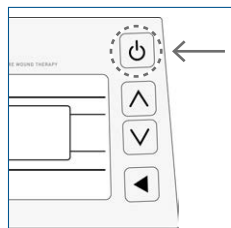

Encienda el aspirador Invia Liberty pulsando la tecla [].

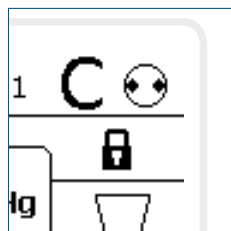

Vista de la pantalla cuando el aspirador está en funcionamiento. El indicador de funcionamiento/espera está girando [].



ADVERTENCIA

No intente efectuar el tratamiento sin la supervisión de su profesional sanitario.



ADVERTENCIA

El sistema de NPWT debe estar en funcionamiento las 24 horas del día. No detenga el tratamiento a menos que así lo indique su profesional sanitario o que se produzca un sangrado excesivo.



ADVERTENCIA

Si se suspende el tratamiento durante más de dos horas, deberá reemplazarse el apósito y el profesional sanitario deberá recomenzar el tratamiento.



ADVERTENCIA

El aspirador Invia Liberty no detecta bloqueos en los tubos conectados al adaptador de drenaje o al brazo curvo del conector en Y. A lo largo del día, supervise con frecuencia el tubo del apósito conectado al adaptador de drenaje o al brazo curvo del conector en Y, para asegurarse de que el tubo no esté doblado ni bloqueado.

Si identifica algún bloqueo en el tubo conectado al adaptador de drenaje o en el tubo conectado al brazo curvo del conector en Y, póngase en contacto con su profesional sanitario.

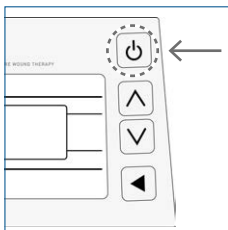

Apagado

Pulse el botón [] durante 3 segundos para apagar el aspirador Invia Liberty. Púselo una sola vez.

Ajuste del maletín de transporte

El aspirador Invia Liberty está concebido para colocarse en un maletín de transporte durante su funcionamiento.



- 1 Abra el maletín de transporte.
- 2 Deslice el aspirador Invia Liberty en el compartimento correspondiente.
- 3 Cierre la solapa de velcro sobre el aspirador.

La bandolera también puede usarse como cinturón.

Para esto, suelte la correa de los lados del maletín de transporte y pásela por las dos presillas ubicadas en la parte posterior del mismo.

Carga de la batería

Cuando la batería está totalmente cargada, el tiempo de uso con batería suele ser superior a 14 horas. Si el aspirador Invia Liberty está funcionando de manera continua debido a una fuga de aire, es posible que la batería deba recargarse antes.

Símbolos de estado de la batería



llena media carga vacía

Si el dispositivo se queda sin batería, siga las siguientes instrucciones.

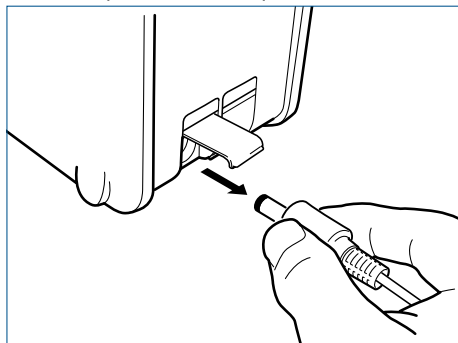

Abra el puerto de alimentación y conecte el Invia Liberty al enchufe eléctrico de la fuente de alimentación suministrada con el aspirador. Conecte el otro extremo de la fuente de alimentación a una toma de pared. Las barras en movimiento que se muestran en el monitor de la batería indicarán que se está cargando.

La batería estará completamente cargada al cabo de unas cuatro horas. Cuando la batería esté totalmente cargada, si permanece conectada a la fuente de alimentación, se mostrará el icono  en la pantalla. Una vez completada la carga, desenchufe la fuente de alimentación de la pared y desconecte el aspirador Invia Liberty de la fuente de alimentación.

Presione hacia abajo la cubierta de protección para cerrar el puerto de alimentación.



PRECAUCIÓN

Debe continuarse con el tratamiento NPWT mientras se carga la batería del aspirador. No apague el aspirador mientras se carga.

Cargue siempre la batería durante la noche.

Puerto del enchufe
adaptador



Cambio del recipiente

Cambie el recipiente como mínimo una vez a la semana o cuando parezca que esté lleno o suene la alarma, de acuerdo con las instrucciones que se muestren en la pantalla del aspirador.

1 Lávese las manos.

2 Pulse el botón de espera [ > 3 segundos] y el motor del aspirador dejará de funcionar.

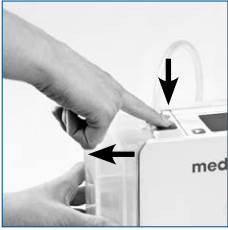
3  Pulse el botón de liberación de la parte superior del aspirador y retire el recipiente.

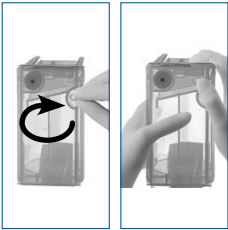
4  Selle el recipiente utilizado con el tope situado en la parte lateral.

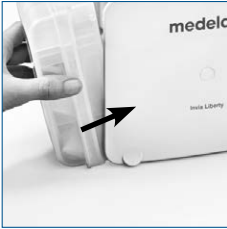
5  Desembale el nuevo recipiente y despegue el adhesivo de seguridad; coloque las clavijas de la parte inferior del mismo en las ranuras que se encuentran en la base del aspirador. Empuje el recipiente hasta que haga clic dentro del aspirador Invia Liberty.



PRECAUCIÓN

No utilice el recipiente Invia Liberty si el empaquetado estéril está dañado.

6



Pulse «On» [] para encender el aspirador Invia Liberty y continuar con el tratamiento, y deslícelo en el interior de su maletín de transporte.

7 Deseche el recipiente usado según las instrucciones suministradas por su profesional sanitario.

Conexión y desconexión del conector rápido

El conector rápido permite desconectar el equipo durante un lapso de tiempo corto (de hasta 20 minutos) para que pueda cambiarse de ropa o asearse. Durante este periodo, puede establecerse el modo de espera en el aspirador durante un intervalo de 5 minutos; transcurrido este tiempo, sonará la alarma del modo de espera y podrá silenciarse durante 5 minutos más.

1 Lávese las manos.

2 Cierre la pinza del tubo del recipiente y cierre la pinza del tubo del apósito.



3 Pulse el botón de espera [ > 3 segundos] y el motor del aspirador dejará de funcionar.

4

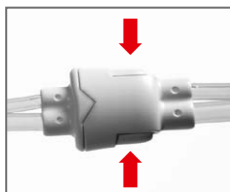

Presione los laterales del conector rápido para desconectarlo.

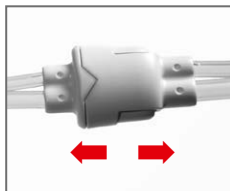

5

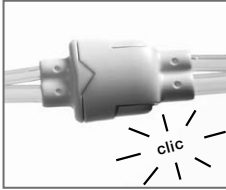
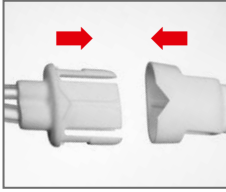

Para volver a conectar el conector rápido, acople sus extremos hasta que oiga un clic.

6



Abra la pinza del tubo del recipiente y abra la pinza del tubo del apósito.

7

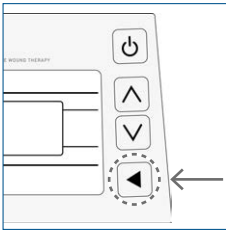

Pulse el botón «On» [◀] para continuar con el tratamiento.

Notificaciones y resolución de problemas



No se asuste si oye una señal acústica.
Siga estas indicaciones.

- 1 Si el aspirador Invia Liberty está en su maletín de transporte, abra la tapa del maletín.
- 2 Pulse [] para silenciar la señal acústica durante 60 segundos (puede pulsar de nuevo cada vez que suene la señal).



Tabla de alarmas

Advertencia	401	<p>Batería baja</p> <p>401</p> <p>Silenciar Standby (3 seg.)</p>	<p>Cargar batería</p> <p>Standby (3 seg.)</p>
	405	<p>Modo standby</p> <p>405</p> <p>Silenciar On</p>	<p>Conecte y desconecte el aspirador</p> <p>On</p>
	406	<p>Temperatura interna alta</p> <p>406</p> <p>Silenciar Standby (3 seg.)</p>	<p>Retire la bomba de la fuente de calor (p.ej., la luz solar directa) o retire cualquier cubierta adicional (p.ej., una manta).</p> <p>Standby (3 seg.)</p>
Alarma	301	<p>Fuga en el sistema</p> <p>301</p> <p>Silenciar Standby (3 seg.)</p>	<p>Controle si hay fugas en el sistema y si el contenedor está correctamente insertado.</p> <p>Consulte las instrucciones de uso para una información adicional.</p> <p>Standby (3 seg.)</p>
	302	<p>Sistema obstruido</p> <p>302</p> <p>Silenciar Standby (3 seg.)</p>	<p>Compruebe que el tubo está limpio y no está enrollado. Compruebe si el contenedor está lleno.</p> <p>Consulte las IDU si desea obtener más instrucciones.</p> <p>Standby (3 seg.)</p>

Comentarios / posible causa del fallo	
	<p>Recargue la batería colocando el aspirador Invia Liberty en la estación de conexión o enchufe el cargador al puerto de alimentación del aspirador.</p> <p>El tiempo restante de la batería es de aproximadamente 30 minutos.</p>
	<p>Si el aspirador permanece en modo de espera durante más de cinco minutos, sonará una alarma.</p> <p>Para continuar con el tratamiento pulse el botón «On» [▶].</p>
	<p>Enfríe el aspirador Invia Liberty siguiendo las instrucciones de la pantalla.</p>
	<p>Apósito:</p> <ul style="list-style-type: none"> - Compruebe que no haya una fuga de aire en el apósito. Presione firmemente los bordes del apósito, alrededor del tubo de drenaje o sobre el Invia FitPad. - Puede aplicar una película adicional para fijar el apósito y sellar el área de fuga. <p>Conexiones:</p> <ul style="list-style-type: none"> - Asegúrese de que el tubo del apósito esté conectado de forma adecuada al tubo del recipiente. - Asegúrese de que el tubo del recipiente esté insertado directamente al aspirador. <p>Recipiente:</p> <ul style="list-style-type: none"> - Asegúrese de que el recipiente esté insertado de forma adecuada; suéltelo y vuelva a colocarlo. - Asegúrese de que no falte la junta tórica naranja que se coloca junto al tubo del recipiente en el aspirador. Puede solicitar más juntas al representante de Medela.
	<p>Llame a su profesional sanitario.</p>

Alarma	305			
	306			
	311			
	313			
Fallo interno				

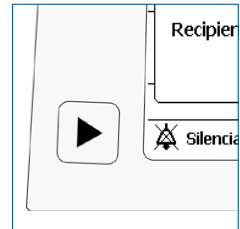

PRECAUCIÓN

Si no puede identificar ningún símbolo o no comprende la alarma que se muestra en la pantalla, póngase en contacto con su profesional sanitario.

Comentarios / posible causa del fallo	
	<p>Recargue la batería colocando el aspirador Invia Liberty en la estación de conexión o enchufe el cargador al puerto de alimentación del aspirador.</p> <p>El tiempo restante de la batería es de aproximadamente 15 minutos.</p>
	<p>Cambie el recipiente (consulte el capítulo «Cambio del recipiente»).</p>
	<p>Recipiente: - Suelte el recipiente y vuelva a colocarlo. Tubo: - Asegúrese de que el tubo no esté doblado, enroscado ni bloqueado.</p>
	<p>Cambie el recipiente (consulte el capítulo «Cambio del recipiente»).</p>
	<p>Reinicie el aspirador. Si persiste el fallo interno, apague el aspirador pulsando [ > 3 segundos] y póngase en contacto con su profesional sanitario.</p>



ADVERTENCIA

Si el aspirador falla o no es posible encenderlo, llame inmediatamente a su profesional sanitario.

Limpieza y desinfección

El aspirador Invia Liberty puede limpiarse con un paño húmedo y un limpiador suave de uso doméstico.



Garantía

La garantía tiene una vigencia de dos años a partir de la fecha de entrega. El fabricante no se responsabilizará de ningún daño o daño indirecto ocasionados por un uso incorrecto o indebido, o por el uso del sistema por parte de personas no autorizadas.



Mantenimiento y control de seguridad

El mantenimiento solo puede ser realizado por personal autorizado. El control de seguridad se reduce a la inspección visual de la carcasa y el cargador para detectar cualquier daño y se debe llevar a cabo antes de cada uso. Si no se utiliza el aspirador Invia Liberty, la batería debe recargarse aproximadamente una vez cada seis meses para asegurar su óptimo funcionamiento.



Eliminación

Consulte con su profesional sanitario el mejor modo de desechar los apósitos, recipientes y tubos usados.



Especificaciones técnicas



Condiciones de almacenamiento de los accesorios

Los accesorios deben permanecer en su embalaje y almacenarse a una temperatura comprendida entre -20° y 50° Celsius.

Condiciones ambientales de funcionamiento



El aspirador Invia Liberty y sus accesorios deben utilizarse a una temperatura comprendida entre 5° y 40° Celsius. No utilice los productos en condiciones de frío o calor extremo. Evite altos niveles de humedad relativa (se admite un intervalo del 15-93 %).



PRECAUCIÓN

No utilice el aspirador Invia Liberty a más de 3000 m por encima del nivel del mar.

Clase de protección IP33

IP33

El aspirador Invia Liberty está protegido frente a la entrada de objetos extraños sólidos de más de 2,5 mm, así como de gotas de agua.

Signos y símbolos



Este símbolo acompaña a una PRECAUCIÓN o ADVERTENCIA asociada al dispositivo.



Este símbolo indica que se trata de un dispositivo de clase II.



No deseche este dispositivo junto con otros residuos urbanos sin clasificar (aplicable solo a la UE).



Este símbolo muestra la fecha de fabricación (cuatro dígitos para el año y dos para el mes).



Este símbolo indica el nombre y la dirección del fabricante.



Este símbolo indica que este dispositivo necesita prescripción médica. PRECAUCIÓN: De acuerdo con la legislación federal de Estados Unidos, la venta de este dispositivo solo podrá realizarla un médico u otra persona a petición de un médico (solo aplicable a Estados Unidos).



Este símbolo acompaña a una pieza aplicada de tipo BF.



Este símbolo indica el número de catálogo del fabricante.



Este símbolo indica el número de serie del fabricante.



Este símbolo indica el código de lote del fabricante.

STERILE EO

Este símbolo indica que el dispositivo se ha esterilizado mediante óxido de etileno.



Este símbolo indica el año y el mes a partir del cual debe dejar de utilizarse el dispositivo.



Este símbolo recomienda seguir las instrucciones de uso.



Este símbolo indica el cumplimiento de requisitos adicionales de seguridad de EE. UU. y Canadá para equipos eléctricos sanitarios.



Este símbolo indica que no se debe utilizar el dispositivo si el embalaje está dañado.

IP33

Este símbolo indica protección contra la entrada de objetos sólidos externos y contra los efectos dañinos causados por la entrada de agua.



Este símbolo indica que el artículo marcado o sus materiales forman parte de un proceso de recuperación o reciclaje.



Este símbolo indica los límites de humedad para el funcionamiento y el almacenamiento.



Este símbolo muestra los límites de presión atmosférica para el funcionamiento y el almacenamiento del dispositivo.



Este símbolo indica que hay que mantener el dispositivo seco.

pcs

Este símbolo indica el número de artículos.



Este símbolo indica la toma de corriente continua.



Este símbolo acompaña a un dispositivo de un solo uso. No reutilice el dispositivo.



Este símbolo indica el límite de temperatura de funcionamiento, transporte y almacenamiento.



Este símbolo recomienda mantener el dispositivo alejado de la luz solar.



Este símbolo recomienda que se trate el dispositivo frágil con cuidado.



Este símbolo indica que el dispositivo cumple la Directiva 93/42/CEE relativa a los productos sanitarios.



Este símbolo indica la posición vertical correcta del embalaje de transporte.

Compatibilidad electromagnética (CEM)

El Invia Liberty ha superado las pruebas CEM según los requisitos de las normas CEI 60601-1-2:2007 y CEI 60601-1-2:2014, 4.ª edición, en lo relativo a las cláusulas 7 y 8.9.



ADVERTENCIA

El aspirador Invia Liberty no debe utilizarse al lado, encima o debajo de otros dispositivos. En caso de que fuera necesario colocarlo junto a otros equipos, compruebe que el aspirador funciona con normalidad en dicha posición.



ADVERTENCIA

No utilice accesorios distintos de los recomendados o vendidos por el fabricante como piezas de sustitución de componentes internos. Esto podría causar un aumento de las emisiones o disminuir la inmunidad del aspirador Invia Liberty.



ADVERTENCIA

Compatibilidad electromagnética (CEM)

Los equipos quirúrgicos de HF (alta frecuencia), las redes de radio y similares pueden afectar al funcionamiento del dispositivo y no se deben usar en combinación con el aspirador Invia Liberty.

Assistência

Leia integralmente o manual de instruções antes de tentar operar o dispositivo.

Caso tenha quaisquer dúvidas sobre o seu sistema de Terapia de Pressão Negativa para Feridas Invia Liberty, contacte o seu médico / prestador de cuidados de saúde através do número indicado em baixo:

PRESTADOR DE CUIDADOS DE SAÚDE/
MÉDICO INFORMAÇÕES DE CONTACTO:

Mantenha este manual de Instruções de Utilização para o doente num local de fácil acesso.

Índice

Avisos, advertências e instruções de segurança	116
Avisos gerais.....	116
Finalidade do dispositivo	118
Utilização prevista	118
Quando utilizar o dispositivo (Indicações de utilização)	119
Quando não utilizar o dispositivo (Contraindicações)	119
Descrição do dispositivo	120
Ecrã	121
Condições que afetam a utilização	121
Segurança geral no domicílio	122
Sono	123
Duches, banhos e lavagens	123
Ao sair de casa	124
Instruções de montagem	124
Preparar o estojo de transporte	126
Carregamento da bateria	126
Mudar o recipiente	128
Ligar/desligar o conector rápido	129
Notificações e resolução de problemas	131
Tabela de alarmes	132
Limpeza/desinfecção	136
Garantia	136
Manutenção/verificação relacionada com a segurança	136
Eliminação	136
Especificações técnicas	137
Sinais e símbolos	138
Compatibilidade Eletromagnética (CEM)	141

Avisos, advertências e instruções de segurança

AVISO

Indicam uma situação potencialmente perigosa que, caso não seja evitada, poderá resultar em morte ou lesão grave.

CHAMADAS DE ATENÇÃO

Indicam uma situação potencialmente perigosa que, caso não seja evitada, poderá resultar numa lesão menor ou moderada.

Avisos gerais

AVISO

A pessoa responsável pela operação deste dispositivo numa base diária (o doente, o prestador de cuidados) deverá conseguir ler, compreender e seguir as indicações contidas nestas instruções de utilização, no visor da bomba e dadas pelo profissional de saúde. A pessoa deverá ter capacidade auditiva e responder a sinais sonoros.

Utilize o sistema de NPWT Invia Liberty apenas na pessoa à qual foi prescrito e apenas para a utilização a que se destina.

Não execute a terapia sem primeiro consultar o pessoal de cuidados de saúde e os prestadores de cuidados que tenham recebido formação sobre as instruções de utilização e a supervisão dos profissionais de saúde.

É proibida qualquer modificação deste equipamento.

AVISO

Verifique visualmente o penso da ferida e o sistema Invia Liberty de forma frequente.

Se vir grandes quantidades de sangue no penso, nos tubos ou no recipiente:

- 1 Desligue a bomba, premindo  sem soltar durante 3 segundos.
- 2 Aplique pressão na ferida.



3 Procure de imediato assistência médica de emergência. Se sentir dificuldades em respirar, procure assistência médica de emergência imediata.

 **AVISO**

Contacte imediatamente o seu profissional de saúde se sentir os seguintes sintomas:

- Perda de visão ou audição significativa
- Dor, sensibilidade ou vermelhidão em torno da ferida
- Edema, prurido ou irritação em torno da ferida
- Febre
- Odor forte da ferida
- Exsudado espesso de cor verde ou qualquer alteração pouco habitual na cor do exsudado
- Náusea, vômitos ou diarreia
- Dor de garganta com edema
- Tonturas ou confusão
- Reações alérgicas como vermelhidão, irritação ou urticária, edema ou prurido grave

 **AVISO**

Depois de o profissional de saúde ter definido a pressão da bomba e as definições do modo, não prima qualquer outro botão além do botão para ligar/desligar [], o botão de espera [] ou o botão para cancelar o som [].

 **AVISO**

A bomba deve ser utilizada 24 horas por dia. Não interrompa o funcionamento da bomba, salvo se receber instruções do seu profissional de saúde ou se ocorrer uma hemorragia excessiva. Se interromper o funcionamento da bomba durante um período superior a 2 horas, tem de mudar o penso. Contacte o seu profissional de saúde para solicitar a mudança do penso.

 **AVISO**

Se a bomba deixar de funcionar e não for possível ligá-la, contacte de imediato o seu profissional de saúde.

Finalidade do dispositivo

O seu fornecedor de cuidados de saúde prescreveu-lhe um sistema NPWT (Terapia de Pressão Negativa para Feridas).

A Terapia de Pressão Negativa para Feridas tem demonstrado ajudar a promover a cura em vários tipos de feridas diferentes.

A pressão negativa (sucção) é aplicada à ferida através de uma bomba. A sucção, ou pressão negativa, ajuda a remover os fluidos e a fechar a ferida. O seu profissional de saúde colocará um penso especial na ferida e um tubo que liga a ferida ao recipiente na bomba. A bomba é então ligada com a pressão prescrita para remover os fluidos da ferida. O fluido é então encaminhado para o recipiente. O tratamento mantém-se ativo 24 horas por dia.

Utilização prevista

Utilizador previsto

O sistema de NPWT Invia Liberty destina-se a ser utilizado por profissionais de saúde ou por utilizadores leigos que tenham recebido a formação adequada. Os profissionais de saúde são responsáveis por formar os utilizadores leigos de acordo com as instruções de utilização para o doente e por explicar todas as informações relacionadas com a segurança.

População de doentes prevista

O sistema de NPWT Invia Liberty destina-se a ser utilizado apenas em doentes com as patologias descritas nas indicações de utilização. O dispositivo não foi ainda estudado em doentes pediátricos.

Ambiente previsto

O sistema de NPWT Invia Liberty destina-se a ser utilizado em cenários de cuidados agudos, prolongados ou domiciliários.

Quando utilizar o dispositivo (Indicações de utilização)

O sistema de NPWT (Terapia de Pressão Negativa para Feridas) Invia Liberty é indicado para doentes que possam beneficiar de um dispositivo de sucção (NPWT) uma vez que cria um ambiente que promove a cura de feridas através de uma intenção secundária ou terciária (primária atrasada) ao preparar o leito da ferida para o fecho, reduzindo o edema, promovendo a formação de tecido de granulação e a perfusão e removendo o exsudado e material infeccioso.

Quando utilizado em incisões cirúrgicas fechadas, o sistema de NPWT Invia Liberty também se destina a tratar o ambiente de incisões cirúrgicas que continuem a drenar após o fecho suturado ou agrafado, mantendo um ambiente fechado e removendo o exsudado através da aplicação da Terapia de Pressão Negativa para Feridas.

O sistema de NPWT Invia Liberty é adequado para as seguintes indicações:

- Feridas agudas ou subagudas
- Feridas crónicas
- Feridas deiscuentes
- Úlceras de pressão
- Úlceras diabéticas/neuropáticas
- Úlceras de insuficiência venosa
- Feridas traumáticas
- Queimaduras de espessura parcial
- Retalhos e enxertos
- Incisões cirúrgicas fechadas

Quando não utilizar o dispositivo (Contraindicações)

O sistema de NPWT Invia Liberty é contraindicado na presença de:

- Tecido necrótico com escara
- Osteomielite não tratada
- Fístulas não entéricas e não exploradas
- Malignidade na ferida
- Vasculatura exposta
- Nervos expostos
- Local anastomótico exposto de vasos sanguíneos ou bypasses
- Órgãos expostos

Se tiver dúvidas, converse com o seu profissional de saúde.

Descrição do dispositivo

Verifique a embalagem de entrega do sistema Invia Liberty relativamente à presença e estado geral de todos os componentes.



AVISO

Não utilize quaisquer outros acessórios além dos acessórios descritos abaixo.



* Produto não disponível em todos os países

Ecrã

Botões para operar a bomba Invia Liberty

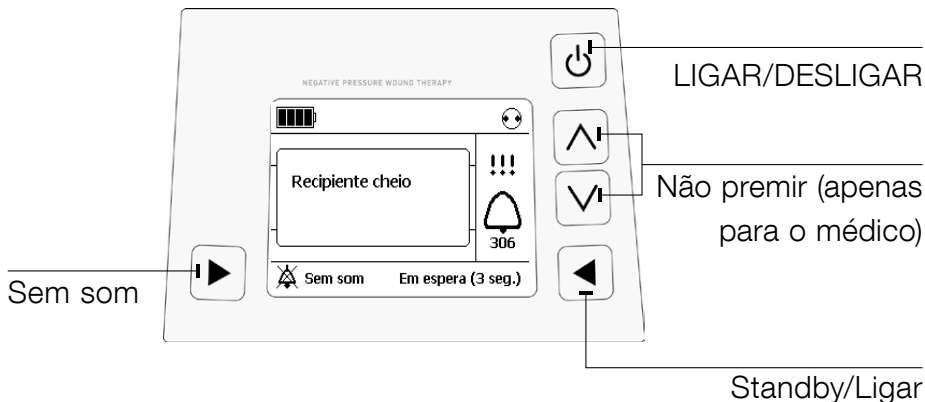

Condições que afetam a utilização



ATENÇÃO

Durante a utilização, a bomba Invia Liberty deve ser mantida na posição vertical.



Segurança geral no domicílio



Leia e observe estes avisos e instruções de segurança antes de colocar o aparelho em funcionamento. Estas instruções de utilização devem ser conservadas com o dispositivo. Tenha em conta que estas instruções de utilização constituem uma orientação geral para o uso do produto. As situações médicas deverão ser solucionadas por um médico.

CHAMADAS DE ATENÇÃO/ADVERTÊNCIAS

- Não utilize extensões elétricas com a bomba Invia Liberty.
- Posicione o cabo de alimentação de tal forma que não provoque tropeções e quedas.
- Nunca coloque o cabo de alimentação à volta do pescoço.
- Mantenha o cabo de alimentação afastado de superfícies quentes.
- Não desligue o cabo de alimentação elétrica da tomada de parede puxando pelo cabo.
- Não tente alterar nem reparar a bomba Invia Liberty. Contacte o seu profissional de saúde se a bomba não estiver a funcionar.
- Mantenha a bomba Invia Liberty seca e limpa.
- Nunca coloque a bomba Invia Liberty em água ou noutros líquidos.
- Caso a bomba Invia Liberty se molhe, seque com uma toalha.
- Não seque a bomba Invia Liberty num forno micro-ondas.
- Mantenha a bomba Invia Liberty afastada de crianças e de animais.
- É necessária a supervisão quando a bomba Invia Liberty for utilizada nas imediações de crianças.
- Mantenha a bomba Invia Liberty protegida da luz solar direta.
- Perigo de explosão – a bomba Invia Liberty não se destina a utilização em ambientes potencialmente explosivos e em áreas em que existam substâncias anestésicas inflamáveis.
- Os equipamentos de comunicação sem fios, como, por exemplo, dispositivos numa rede doméstica sem fios, telemóveis, telefones sem fios e respetivas estações de base e walkie-

talkies, podem interferir com a bomba Invia Liberty e devem ser mantidos a uma distância mínima de 30 cm da bomba Invia Liberty. Esta situação pode provocar o carregamento da bateria insuficiente ou resultar em avaria interna. Consulte o capítulo Notificações e a resolução de problemas para aceder às ações a realizar em caso de avaria interna.

- Este produto contém baterias de iões de lítio que acarretam o risco de incêndio, explosão e queimaduras. Não desmonte, parta, aqueça acima dos 100 °C, incinere nem elimine no fogo.

Se observar uma alteração no nível de vácuo ou uma condição de erro, afaste a bomba Invia Liberty, no mínimo, 30 cm do telemóvel ao efetuar ou receber chamadas. Ligue a bomba Invia Liberty e desligue novamente para repô-la após uma condição de erro. Sempre que possível, é recomendada uma distância mínima de 30 cm entre a bomba Invia Liberty e um telemóvel.

Sono



- Certifique-se de que não dobra o conjunto de tubos da bomba Invia Liberty.
- Evite que a bomba Invia Liberty caia no chão enquanto dorme.
- Carregue sempre a bomba Invia Liberty ao deitar-se.

Duches, banhos e lavagens



- Não utilize a bomba Invia Liberty em banhos ou duches.
- A bomba Invia Liberty pode ser desligada do penso durante um período de tempo reduzido (até 20 minutos) para mudar de roupa ou realizar a sua higiene pessoal. Debata os planos de banhos com o seu profissional de saúde.
- Evite que a bomba Invia Liberty se molhe.
- Não coloque a bomba Invia Liberty num local em que possa cair num chuveiro, lavatório ou banheira.
- Não toque na bomba Invia Liberty caso tenha caído dentro de água. Desligue imediatamente o dispositivo da corrente elétrica e desligue a bomba do penso.

Ao sair de casa



- Verifique o estado da bateria e recarregue, conforme necessário, antes de sair de casa.
- Para sua comodidade, coloque a bomba Invia Liberty no estojo de transporte.
- Não se esqueça de levar consigo um recipiente sobressalente e uma fonte de alimentação de reserva.

Instruções de montagem



AVISO

Verifique frequentemente a bomba Invia Liberty e o penso para se certificar de que estão a funcionar. Verifique visualmente o penso da ferida, a área em torno da ferida e o fluido no recipiente para identificar sinais de infeção ou outras complicações tal como indicado pelo profissional de saúde.

Ligar

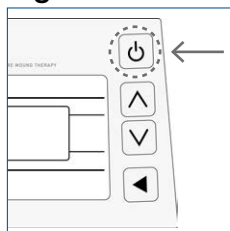

Ligue a bomba Invia Liberty premindo [].

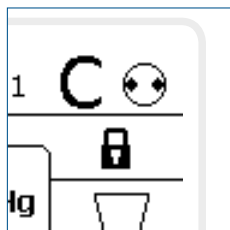

Vista do ecrã com a bomba em funcionamento. O indicador de Funcionamento/ Standby está a rodar [].

**AVISO**

Não tente realizar a terapia sem a supervisão do seu profissional de saúde.

**AVISO**

A NPWT tem de funcionar 24 horas por dia. Não interrompa a terapia, salvo se receber instruções do seu profissional de saúde ou se ocorrer uma hemorragia excessiva.

**AVISO**

O penso deve ser mudado e a terapia reiniciada pelo profissional de saúde se a terapia for descontinuada por um período superior a 2 horas.

**AVISO**

A bomba Invia Liberty não deteta bloqueios nos tubos ligados ao adaptador de drenagem ou ligados ao braço curvo do conector em Y. Verifique frequentemente os tubos do penso ligados ao adaptador de drenagem ou ao braço curvo do conector em Y ao longo do dia para se certificar de que os tubos não estão dobrados ou bloqueados.

Se forem identificados bloqueios nos tubos ligados ao adaptador de drenagem ou aos tubos ligados ao braço curvo do conector em Y, contacte o seu profissional de saúde.

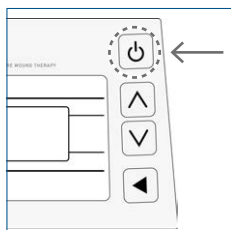
**Desligar**

Desligue a bomba Invia Liberty premindo [] durante 3 segundos. Prima apenas uma vez.

Preparar o estojo de transporte

A bomba Invia Liberty destina-se a ser utilizada num estojo de transporte durante o funcionamento.



- 1 Abra o estojo de transporte.
- 2 Deslize a bomba Invia Liberty para o bolso designado.
- 3 Feche o velcro sobre a bomba.

A alça de ombro também pode ser utilizada como correia para a cintura.

Para fazê-lo, solte a alça dos lados do estojo de transporte e puxe-a pelas duas laçadas situadas na parte traseira do estojo de transporte.

Carregamento da bateria

Quando a bateria está completamente carregada, a autonomia geralmente ultrapassa as 14 horas. Se a bomba Invia Liberty estiver a funcionar continuamente devido a uma fuga de ar, a bateria poderá ter de ser carregada mais cedo.

Símbolos de estado da bateria



cheia



meia



totalmente descarregada (vazia)

Se a bateria ficar totalmente descarregada (vazia), siga as instruções abaixo.

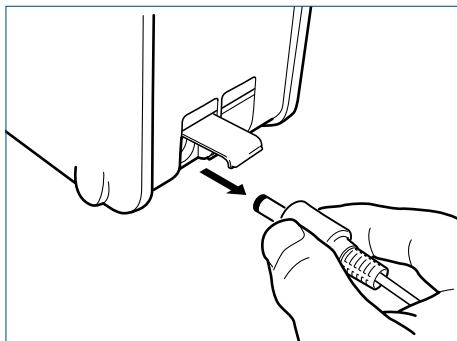

Abra a porta de saída elétrica. Ligue a bomba Invia Liberty à ficha elétrica fornecida da fonte de alimentação fornecida com a bomba. Ligue a outra extremidade do cabo de alimentação a uma tomada de parede. As barras em movimento no símbolo da bateria indicam que esta se encontra em carregamento.

A bateria carrega totalmente após cerca de 4 horas. Depois de a bateria estar completamente carregada e permanecer ligada a uma fonte de alimentação,  aparece fixo no ecrã. Quando o carregamento estiver concluído, desligue o cabo de alimentação da tomada de parede e desligue a bomba Invia Liberty do cabo de alimentação.

Feche a porta de saída elétrica pressionando a tampa de proteção para baixo.



ATENÇÃO

A terapia NPWT deve ser continuada durante o carregamento da bateria da bomba. Não desligue a bomba durante o carregamento.

Carregue sempre a bateria durante a noite.

Porta de saída elétrica



Mudar o recipiente

Mude o recipiente, no mínimo, uma vez por semana ou quando lhe parecer cheio ou quando for emitido um alarme sonoro, de acordo com as instruções apresentadas no ecrã da bomba.

1 Lave as mãos.

2 Prima o botão “Standby” [ > 3 segundos] e o motor da bomba interrompe o funcionamento.

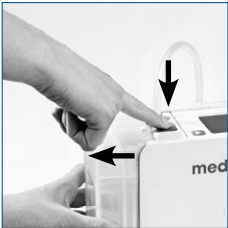
3  Prima o botão de libertação na parte superior da bomba e retire o recipiente.

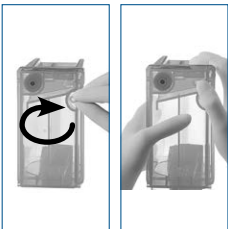
4  Sele o recipiente utilizado com uma tampa situada na parte lateral do recipiente.

5  Desembale um novo recipiente e retire o autocolante de segurança e coloque os pés da parte inferior do recipiente nas ranhuras que se encontram na base da bomba. Empurre o recipiente para cima e encaixe com um estalido na bomba Invia Liberty.



ATENÇÃO

Não utilize um recipiente Invia Liberty se a embalagem estéril estiver danificada.

6



Ligue a bomba Invia Liberty premindo “Ligar” [] para retomar a terapia e deslize a bomba no estojo de transporte.

7 Elimine o recipiente usado de acordo com as instruções fornecidas pelo seu profissional de saúde.

Ligar/desligar o conector rápido

O conector rápido pode ser desligado do penso durante um período de tempo reduzido (até 20 minutos) para mudar de roupa ou realizar a sua higiene pessoal. Durante este período de tempo, a bomba pode ser colocado no modo “Standby” durante um intervalo de 5 minutos, período após o qual é emitido o alarme de “Modo Standby”, que pode ser silenciado por mais 5 minutos.

1 Lave as mãos.

2 Feche a pinça no tubo do recipiente e feche a pinça no tubo do penso.

3 Prima o botão “Standby” [ >

3 segundos] e o motor da bomba interrompe o funcionamento.

4

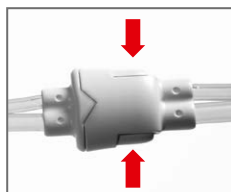

Desligue o conector rápido premindo por baixo dos lados do conector.

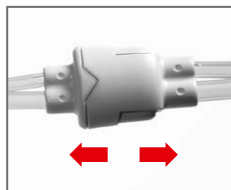

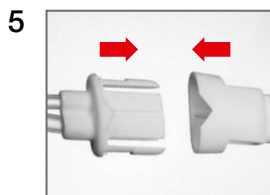

Para ligar novamente o conector rápido, empurre o conector rápido até ouvir um estalido.

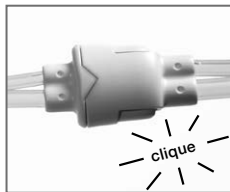

Abra a pinça no tubo do recipiente e abra a pinça no tubo do penso.

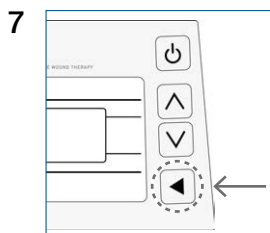

Prima “Ligar” [] para retomar a terapia.

Notificações e resolução de problemas



Não entre em pânico se ouvir um sinal sonoro.
Siga as instruções abaixo.

- 1 Se a bomba Invia Liberty estiver no estojo de transporte, abra a tampa do estojo de transporte.
- 2 Prima [] para silenciar o sinal sonoro durante 60 segundos (pode ser premido de cada vez que o sinal soar).





Tabela de alarmes

Aviso	401		
	405		
	406		
Alarme	301		
	302		

Observações/possível causa da avaria	
	<p>Recarregue a bateria colocando a bomba Invia Liberty na estação de carga ou ligando o carregador à porta de saída elétrica na bomba.</p> <p>O tempo de funcionamento restante é de aprox. 30 minutos.</p>
	<p>Se a bomba estiver no modo Standby durante mais de 5 minutos, é despoletado um alarme.</p> <p>Para continuar a terapia, prima “Ligar” []</p>
	<p>Arrefeça a bomba Invia Liberty de acordo com as instruções apresentadas no ecrã.</p>
	<p>Penso:</p> <ul style="list-style-type: none"> – Verifique o penso quanto à existência de fugas de ar. Pressione firmemente em torno dos rebordos do penso, em torno do tubo de drenagem ou no Invia FitPad. – Poderá aplicar um penso de película adicional para selar a área com fuga. <p>Conectores:</p> <ul style="list-style-type: none"> – Certifique-se de que os tubos ligados ao penso estão corretamente ligados aos tubos do recipiente. – Certifique-se de que os tubos do recipientes estão corretamente inseridos na bomba. <p>Recipiente:</p> <ul style="list-style-type: none"> – Certifique-se de que o recipiente está corretamente introduzido: solte o recipiente e posicione novamente. – Certifique-se de que o anel em O/junta laranja, colocado junto aos tubos do recipiente na bomba não está em falta. Estão disponíveis anéis em O adicionais junto de um representante da Medela.
	<p>Contacte o seu profissional de saúde.</p>

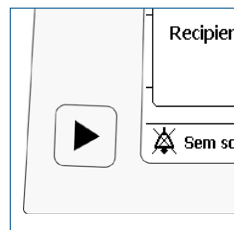
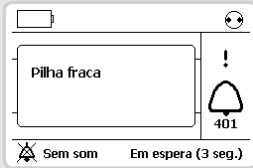
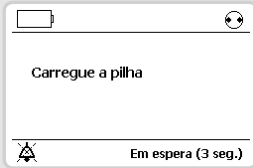
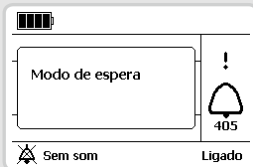
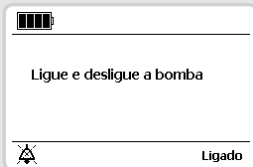
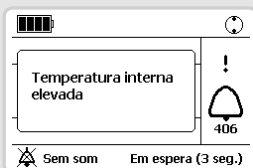
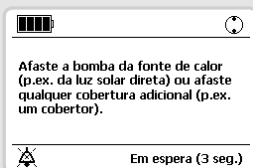
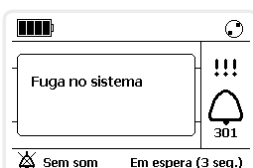
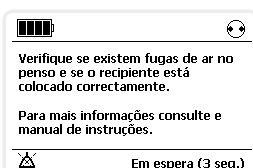
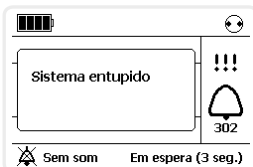
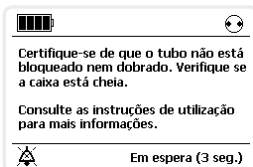
Alarme	305		
	306		
	311		
	313		
Falha interna			



ATENÇÃO

Se não conseguir identificar qualquer símbolo ou se não compreender o alarme no ecrã, contacte o seu profissional de saúde.

	Observações/possível causa da avaria
	<p>Recarregue a bateria colocando a bomba Invia Liberty na estação de carga ou ligando o carregador à porta de saída elétrica na bomba.</p> <p>O tempo de funcionamento restante é de aprox. 15 minutos.</p>
	<p>Mude o recipiente; consulte o capítulo “Mudar o recipiente”.</p>
	<p>Recipiente: - Solte o recipiente e posicione novamente.</p> <p>Tubos: - Certifique-se de que os tubos não estão torcidos, dobrados ou apertados.</p>
	<p>Mude o recipiente; consulte o capítulo “Mudar o recipiente”.</p>
	<p>Reinicie a bomba. Se a falha interna persistir, desligue premindo [ > 3 segundos] e contacte o seu profissional de saúde.</p>



AVISO

Se a bomba falhar e não for possível ligá-la, contacte de imediato o seu profissional de saúde.

Limpeza/desinfecção

A bomba Invia Liberty pode ser limpa com um pano húmido utilizando um detergente doméstico suave.



Garantia

O período de garantia é de 2 anos a partir da data de entrega. O fabricante não é responsável por quaisquer danos ou danos consequenciais causados por uma operação incorreta, utilização não conforme e manipulação por pessoas não autorizadas.



Manutenção/verificação relacionada com a segurança

Os trabalhos de manutenção só devem ser realizados por pessoas autorizadas. Uma verificação relacionada com a segurança limita-se a uma inspeção visual da estrutura e do carregador quanto a danos e deve ser realizada antes de cada utilização. Caso a bomba Invia Liberty não seja utilizada com muita frequência, a bateria deve ser carregada aproximadamente a cada 6 meses, para assegurar o melhor funcionamento.



Eliminação

Pergunte ao seu profissional de saúde como pode eliminar pensos, recipientes e tubos usados.



Especificações técnicas



Condições de armazenamento dos acessórios

Os acessórios devem permanecer na embalagem e armazenados a uma temperatura entre - 20 °C e + 50 °C.



Condições ambientais de funcionamento

A bomba Invia Liberty e os seus acessórios têm de ser operados a um intervalo de temperaturas entre + 5 °C e + 40 °C. Não opere os produtos a temperaturas extremas, altas ou baixas. Evite a humidade relativa elevada (15 – 93% permissível).



ATENÇÃO

Não opere a bomba Invia Liberty num local a mais de 3000 metros acima do nível do mar.

PT

Classe de proteção IP33

IP33

A bomba Invia Liberty está protegida da entrada de sólidos com mais de 2,5 milímetros e gotas de água.

Sinais e símbolos



Este símbolo indica uma chamada de ATENÇÃO ou AVISO associados ao dispositivo.



Este símbolo indica um dispositivo de classe II.



Não eliminar o dispositivo em conjunto com resíduos urbanos indiscriminados (apenas na UE).



Este símbolo indica a data de fabricação (quatro dígitos para o ano e dois dígitos para o mês).



Este símbolo indica o nome e a morada do fabricante.



Este símbolo indica que se trata de um dispositivo a utilizar mediante prescrição médica. ATENÇÃO: A lei federal dos EUA só permite a venda deste dispositivo a médicos ou por indicação de um médico (apenas para os EUA).



Este símbolo indica uma peça aplicada de tipo BF.



Este símbolo indica o número de catálogo do fabricante.



Este símbolo indica o número de série do fabricante.



Este símbolo indica o código de lote do fabricante.

STERILE EO

Este símbolo indica que o dispositivo foi esterilizado com óxido de etileno.



Este símbolo indica que o dispositivo não deve ser utilizado após o final do ano e mês indicados.



Este símbolo indica que é necessário seguir as instruções de utilização.



Este símbolo indica a conformidade com os requisitos de segurança adicionais dos EUA e do Canadá para equipamentos médicos elétricos.



Este símbolo indica que o dispositivo não deve ser utilizado se a embalagem se apresentar danificada.

IP33

Este símbolo indica a proteção contra a entrada de objetos sólidos estranhos e contra os efeitos nocivos causados pela entrada de água.



Este símbolo indica que o item assinalado ou o seu material é parte de um processo de recuperação ou reciclagem.



Este símbolo indica a limitação de humidade para efeitos de funcionamento e armazenamento.



Este símbolo indica a limitação da pressão atmosférica para efeitos de funcionamento e armazenamento.



Este símbolo indica que é necessário manter o dispositivo seco.

pcs

Este símbolo indica o número de unidades.



Este símbolo indica uma tomada de corrente contínua.



Este símbolo indica um dispositivo de utilização única. Não reutilize o dispositivo.



Este símbolo indica o limite de temperatura para o funcionamento, o transporte e o armazenamento.



Este símbolo indica que é necessário manter o dispositivo ao abrigo da luz solar.



Este símbolo indica que é necessário manusear o dispositivo frágil com cuidado.



Este símbolo indica que o dispositivo está em conformidade com a Diretiva relacionada com dispositivos médicos 93/42/EEC.



Este símbolo indica a posição vertical correta da embalagem de transporte.

Compatibilidade Eletromagnética (CEM)

O Invia Liberty foi testado quanto à CEM, em conformidade com os requisitos das normas IEC 60601-1-2:2007 e IEC 60601-1-2:2014, 4.ª Edição, de acordo com as cláusulas 7 e 8.9.



AVISO

A bomba Invia Liberty não deve ser utilizada contígua ou empilhada com outros equipamentos. Se a utilização contígua ou empilhada for necessária, a bomba Invia Liberty deve ser observada para verificar o funcionamento normal na configuração em que será utilizada.



AVISO

Não utilize outros acessórios além dos especificados ou vendidos pelo fabricante como peças de substituição para componentes internos dado que tal pode resultar num aumento das emissões ou diminuição da imunidade da bomba Invia Liberty.



AVISO

CEM

O equipamento cirúrgico de alta frequência, as redes de rádio ou semelhantes podem afetar o funcionamento do dispositivo e não devem ser operados em combinação com a bomba Invia Liberty.

Assistentie

De gebruiksaanwijzing volledig lezen alvorens het apparaat te gaan bedienen.

Heeft u vragen over uw Invia Liberty systeem voor negatieve druktherapie, neem dan contact op met uw zorgverlener of arts op het onderstaande nummer:

ZORGVERLENER/ARTS
CONTACTINFORMATIE:

Bewaar deze gebruiksaanwijzing voor de patiënt op een gemakkelijk te bereiken plaats.

Inhoudsopgave

Waarschuwingen, opmerkingen en veiligheidsinstructies	144
Algemene waarschuwingen	144
Het doel van het hulpmiddel	146
Beoogd gebruik	146
Wanneer het apparaat moet worden gebruikt (Therapeutische indicaties)	147
Wanneer het apparaat niet moet worden gebruikt (Contra-indicaties)	147
Beschrijving van het apparaat	148
Display	149
Omstandigheden die het gebruik beïnvloeden	149
Algemene veiligheid thuis	150
Slapen	151
Douchen, baden en wassen	151
Als u het huis verlaat	152
In elkaar zetten	152
Draagtas inrichten	154
Accu laden	154
Opvangpot verwisselen	156
Quick-connector voor aan-/afsluiten	157
Meldingen en problemen oplossen	159
Tabel Alarmen	160
Reiniging/desinfectie	164
Garantie	164
Onderhoud / routinematige veiligheidscontrole	164
Afvoer	164
Technische specificaties	165
Pictogrammen en symbolen	166
Elektromagnetische compatibiliteit (EMC)	169

Waarschuwingen, opmerkingen en veiligheidsinstructies



WAARSCHUWING

Verwijst naar een potentieel gevaarlijke situatie, die zonder passende tegenmaatregelen tot ernstige verwondingen of levensgevaar kan leiden.



OPMERKING

Verwijst naar een potentieel gevaarlijke situatie, die zonder tegenmaatregelen tot lichte of matige verwondingen kan leiden.

Algemene waarschuwingen



WAARSCHUWING

De persoon die verantwoordelijk is voor de dagelijkse bediening van dit apparaat (patiënt, zorgverlener) moet in staat zijn de instructies van de professionele zorgverlener en de in deze gebruiksaanwijzing opgenomen instructies te lezen, begrijpen en op te volgen. Deze persoon moet geluidssignalen kunnen horen en hierop kunnen reageren. Gebruik het Invia Liberty systeem voor negatieve druktherapie alleen voor de persoon waarvoor hij voorgeschreven is en uitsluitend voor het beoogde doel.

Voer de therapie nooit uit zonder vooraf te overleggen met medisch personeel of zorgverleners die zijn geïnstrueerd over de gebruiksaanwijzing, en altijd onder toezicht van de professionele zorgverlener. Het aanbrengen van aanpassingen aan deze apparatuur is niet toegestaan.



WAARSCHUWING

Voer regelmatig een visuele controle op het wondverband en het Invia Liberty systeem uit.

Als u grote hoeveelheden bloed in het wondverband, de slangen of opvangpot aantreft:

- 1 Schakel de pomp uit door op  te drukken en deze 3 seconden ingedrukt te houden.
- 2 Oefen druk uit op de wond.

3 Roep onmiddellijk medische noodhulp in.

Als u moeite heeft met ademen, direct medische noodhulp inroepen.





WAARSCHUWING

Neem onmiddellijk contact op met uw professionele zorgverlener als u last heeft van de volgende symptomen:

- Sterk verminderd zicht of gehoor
- Pijn, gevoeligheid of roodheid rondom de wond
- Zwelling, jeuk of uitslag rondom de wond
- Koorts
- Een sterke geur uit de wond
- Dik groen vocht of een ongewone kleur van het vocht
- Misselijkheid, braken of diarree
- Pijnlijke en opgezwollen keel
- Duizeligheid of verwardheid
- Allergische reacties zoals roodheid, uitslag of galbulten, zwelling of ernstige jeuk



WAARSCHUWING

Als de professionele hulpverlener de pompdruk en modi heeft ingesteld, niet meer op een andere knop drukken dan op de aan/uit-knop [], de stand-by-knop [] of de mute-knop [].



WAARSCHUWING

De pomp moet 24 uur per dag worden gebruikt. De pomp niet uitzetten tenzij uw professionele zorgverlener u instrueert om dat te doen of als er sprake is van zware bloedingen.

Wordt de pomp langer dan 2 uur stopgezet, dan dient het wondverband te worden verschoond. Neem contact op met uw professionele zorgverlener om een verbandwissel aan te vragen.



WAARSCHUWING

Als de pomp niet meer werkt en niet meer kan worden ingeschakeld, onmiddellijk contact opnemen met uw professionele zorgverlener.



Het doel van het hulpmiddel

Uw professionele zorgverlener heeft u negatieve druktherapie voor wondgenezing (NPWT) voorgeschreven.

Negatieve druktherapie voor wondgenezing kan aantoonbaar de genezing van uiteenlopende wondtypen bevorderen. Er wordt via een (vacuüm)pomp negatieve druk op de wond opgebouwd. Het vacuüm (de negatieve druk) helpt om vloeistoffen te verwijderen en uw wond te sluiten. Uw professionele zorgverlener zal een speciaal verband op uw wond aanbrengen en er gaat een slangetje van uw wond naar de opvangpot die aan de pomp zit. De pomp wordt vervolgens op de voorgeschreven druk ingesteld om de vloeistoffen uit uw wond te verwijderen. Deze vloeistof komt vervolgens in de opvangpot. De behandeling loopt 24 uur per dag.

Beoogd gebruik

Beoogde gebruiker

Het Invia Liberty systeem voor negatieve druktherapie is bedoeld voor gebruik door medisch personeel of adequaat geïnstrueerde onervaren gebruikers.

De professionele zorgverlener moet onervaren gebruikers instrueren in het gebruik van het systeem en alle veiligheidsgerelateerde informatie uitleggen.

Beoogde patiëntenpopulatie

Het Invia Liberty systeem voor negatieve druktherapie is alleen bedoeld voor gebruik bij patiënten die voldoen aan de therapeutische indicaties zoals beschreven in de gebruiksaanwijzing. Het hulpmiddel is niet onderzocht op het gebruik voor pediatrische patiënten.

Beoogde omgeving

Het Invia Liberty systeem voor negatieve druktherapie is bedoeld voor toepassingen in ziekenhuizen, zorginstellingen en thuissituaties.

Wanneer het apparaat moet worden gebruikt (Therapeutische indicaties)

Het Invia Liberty systeem voor negatieve druktherapie (NPWT) is geïndiceerd voor patiënten die baat kunnen hebben bij een vacuümapparaat (NPWT) omdat het een omgeving creëert die de wondgenezing stimuleert via een secundair of tertiair (vertraagd primair) genezend effect door het voorbereiden van het wondbed op sluiting, verminderen van oedeem, stimuleren van de aanmaak van granulatieweefsel en de perfusie, en door het verwijderen van exsudaat en infectieuze materialen. Bij gesloten chirurgische incisies kan het Invia Liberty systeem voor negatieve druktherapie ook worden ingezet voor het behandelen van de omgeving van chirurgische incisies die na sluiting met hechtdraad of nietjes blijven exsudereren, door het creëren van een gesloten omgeving en het afvoeren van exsudaat middels vacuümtherapie.

Het Invia Liberty systeem voor negatieve druktherapie is geschikt voor gebruik bij de volgende indicaties:

- acute of subacute wonden
- chronische wonden
- deshiscente wonden
- drukulcera
- diabetische/neuropathische ulcera
- veneuze insufficiëntie ulcera
- traumatische wonden
- tweedegraads brandwonden
- huidflappen en transplantaten
- gesloten chirurgische incisies

Wanneer het apparaat niet moet worden gebruikt (Contra-indicaties)

Het Invia Liberty systeem voor negatieve druktherapie is gecontra-indiceerd bij:

- necrotisch weefsel met aanwezige barsten
- onbehandelde osteomyelitis
- niet-enterische en niet onderzochte fistels
- wonden met maligne cellen
- blootliggende vaten
- blootliggende zenuwen
- blootliggende anastomosen van bloedvaten of bypasses
- blootliggende organen

Neem contact op met uw professionele zorgverlener als u zich zorgen maakt.

Beschrijving van het apparaat

Controleer of het geleverde pakket van het Invia Liberty systeem compleet en in goede toestand is.



WAARSCHUWING

Geen accessoires gebruiken die niet in de onderstaande lijst voorkomen.

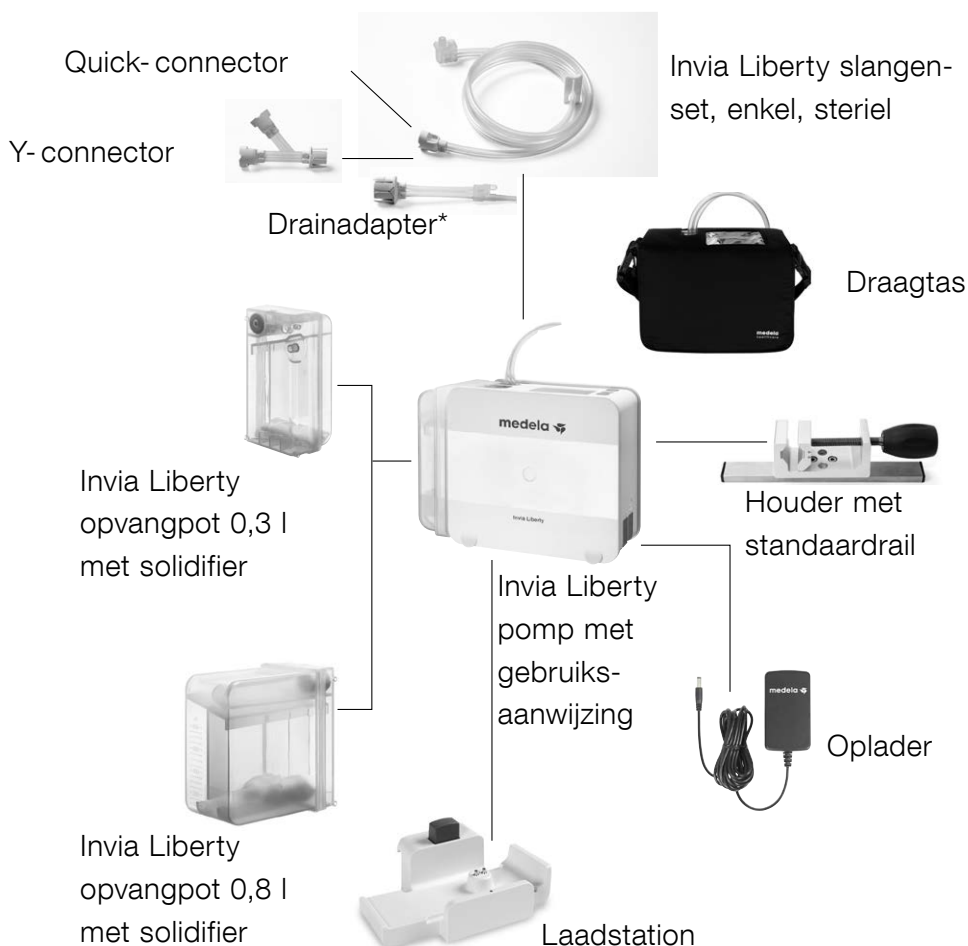

* Product niet verkrijgbaar in alle landen

Display

Bedieningsknoppen van de Invia Liberty pomp

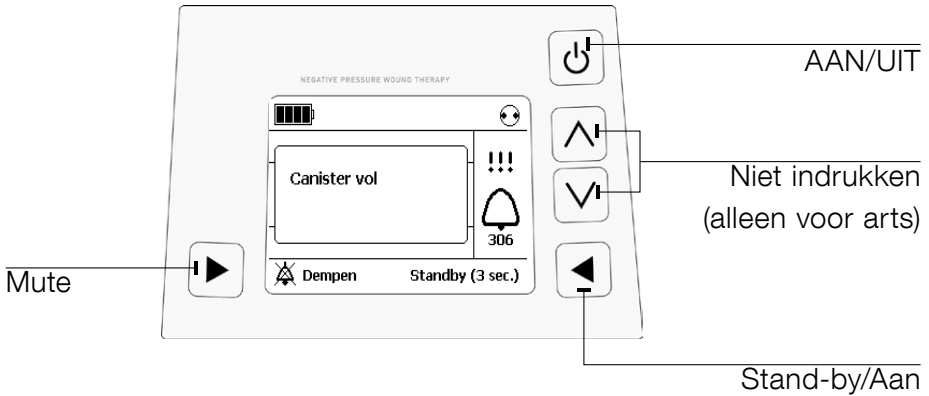

Omstandigheden die het gebruik beïnvloeden



OPMERKING

De Invia Liberty pomp moet tijdens het gebruik steeds rechtop blijven.



Algemene veiligheid thuis



Lees deze waarschuwingen en veiligheidsinstructies goed door voordat u het apparaat in gebruik neemt en volg ze strikt op. Bewaar deze gebruiksaanwijzing bij het apparaat. Let op, deze gebruiksaanwijzing is een algemene handleiding voor het gebruik van dit product. De medische behandeling berust bij de arts.



OPMERKINGEN/WAARSCHUWINGEN

- Gebruik geen verlengsnoeren met de Invia Liberty pomp.
- Plaats het netsnoer zodanig dat er niemand over valt of struikelt.
- Hang het netsnoer nooit om uw nek.
- Houd het netsnoer uit de buurt van warmtebronnen.
- Trek de stekker nooit uit het stopcontact door aan het netsnoer te trekken.
- Probeer de Invia Liberty pomp niet te maken of te repareren. Neem contact op met uw professionele zorgverlener als de pomp niet werkt.
- Houd de Invia Liberty pomp schoon en droog.
- Zet de Invia Liberty pomp nooit in water of in andere vloeistoffen.
- Wanneer de Invia Liberty pomp nat wordt, deze met een droge handdoek afdrogen.
- Droog de Invia Liberty niet in een magnetron.
- Houd de Invia Liberty pomp uit de buurt van kinderen en huisdieren.
- Er dient toezicht te worden gehouden als de Invia Liberty pomp wordt gebruikt in de nabijheid van kinderen.
- Plaats de Invia Liberty pomp niet in direct zonlicht.
- Explosiegevaar – de Invia Liberty pomp is niet geschikt voor gebruik in omgevingen met explosiegevaar, inclusief met zuurstof verrijkte omgevingen en in de nabijheid van ontvlambare anaestesia-gassen.
- Draadloze communicatie-apparatuur zoals draadloze apparaten van een thuisnetwerk, mobiele telefoons, draadloze telefoons en bijbehorende basisstations en walkietalkies kunnen de werking van de Invia Liberty pomp beïnvloeden en dienen op ten minste 30 cm afstand van de Invia Liberty pomp te worden gehouden. Hierdoor

kan de accu onvoldoende worden opgeladen of het kan een interne fout veroorzaken. Raadpleeg het hoofdstuk Meldingen en problemen oplossen voor het oplossen van een interne fout.

- Dit product bevat lithium-ionbatterijen die een risico geven van brand, ontploffing en brandwonden. De batterijen niet uit elkaar halen, breken, verwarmen boven 100 °C, verbranden of in vuur werpen.

Bij een verandering in het vacuümniveau of een foutmelding, de Invia Liberty pomp op ten minste 30 cm afstand plaatsen van mobiele telefoons op het moment dat daarmee wordt gebeld. Zet de Invia Liberty pomp aan en weer uit om hem na een foutmelding te resetten. Geadviseerd wordt een veilige afstand van 30 cm aan te houden tussen een mobiele telefoon en de Invia Liberty pomp.

Slapen



- Voorkom dat de slangpomp van de Invia Liberty geknikt kan raken.
- Voorkom dat de Invia Liberty pomp tijdens slapen op de vloer valt.
- Sluit de Invia Liberty pomp altijd aan op de lader als u naar bed gaat.

Douchen, baden en wassen



- Gebruik de Invia Liberty pomp nooit tijdens het baden of douchen.
- De Invia Liberty pomp kan voor een korte periode (tot 20 minuten) van het wondverband worden afgesloten voor aan- en uitkleden en persoonlijke hygiëne. Bespreek met uw professionele zorgverlener hoe u zich gaat wassen.
- Voorkom dat de Invia Liberty pomp nat wordt.
- Plaats de Invia Liberty pomp nooit zo dat hij in een douche, wasbak of bad kan vallen.
- Raak de Invia Liberty pomp niet aan als hij in het water is gevallen. Haal onmiddellijk de stekker uit het stopcontact en koppel het wondverband los van het apparaat.

Als u het huis verlaat



- Controleer de accustatus en laad deze zo nodig op voordat u het huis verlaat.
- Voor uw gemak kunt u de Invia Liberty pomp in de draagtas plaatsen.
- Vergeet niet een reserveopvangpot en het netsnoer mee te nemen.

In elkaar zetten



WAARSCHUWING

Controleer de Invia Liberty pomp en de wondverbanden zeer regelmatig om te verifiëren of het systeem werkt. Het wondverband, het gebied rondom de wond en de vloeistof in de opvangpot regelmatig op het zicht controleren op tekenen van infecties of andere complicaties, op aanwijzing van uw professionele zorgverlener.

AANzetten

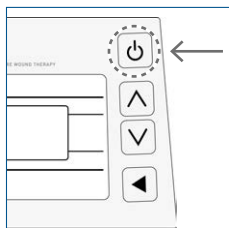

Zet de Invia Liberty pomp AAN door op [] te drukken.

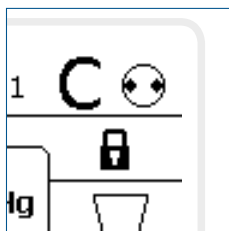

Weergave display als de pomp loopt.
Aan/stand-by-lampje draait [].



WAARSCHUWING

Pas de therapie alleen toe onder toezicht van uw professionele zorgverlener.



WAARSCHUWING

NPWT moet 24 uur per dag worden toegepast. De therapie niet stopzetten tenzij uw professionele zorgverlener u instrueert om dat te doen of als er zware bloedingen optreden.



WAARSCHUWING

Als de therapie gedurende meer dan 2 uur wordt onderbroken, dient het wondverband te worden verschoond en de therapie opnieuw te worden gestart door een professionele zorgverlener.



WAARSCHUWING

De Invia Liberty pomp detecteert geen blokkades in slangen naar de drainadapter of naar de gebogen arm van de Y-connector. De verbandslang naar de drainadapter of de gebogen arm van de Y-connector gedurende de hele dag regelmatig controleren om te kijken of deze niet geknikt of verstopt is.

Neem contact op met uw professionele zorgverlener als er een blokkade is in de slang naar de drainadapter of naar de gebogen arm van de Y-connector.

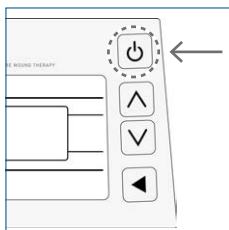

Uitzetten

Zet de Invia Liberty pomp UIT door de knop [] gedurende drie seconden ingedrukt te houden. Niet vaker dan één keer indrukken.

Draagtas inrichten

De Invia Liberty pomp is ontworpen om tijdens het gebruik in een draagtas te worden gedragen.



- 1 Open de draagtas.
- 2 Schuif de Invia Liberty pomp in het hiervoor bestemde vak.
- 3 Maak het klittenband over de pomp vast.

De schouderband kan ook als riemband worden gebruikt. Hiervoor de band aan beide zijden van de draagtas losmaken en door de twee lussen aan de achterkant van de draagtas halen.

Accu laden

Als de accu volledig is opgeladen, bedraagt de werkduur van de accu gewoonlijk meer dan 14 uur. Als de Invia Liberty pomp door een luchtlek continu draait, moet de accu mogelijk eerder worden opgeladen.

Accustatus



vol



halfvol



geheel ontladen (leeg)

Volg de onderstaande instructies als de accu volledig ontladen (leeg) is.

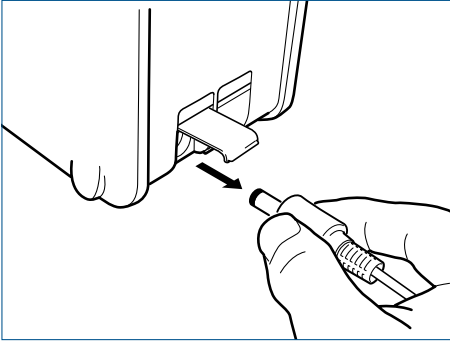

Open de elektrische aansluitpoort. Steek de stekker van het meegeleverde netsnoer in de poort op de Invia Liberty pomp. Steek het andere eind van het netsnoer in een stopcontact. De bewegende balkjes in het accudisplay geven aan dat de accu wordt opgeladen.

De accu is na ongeveer 4 uur volledig opgeladen. Als de accu volledig is opgeladen en als het apparaat aan de stroomvoorziening blijft, wordt  continu op de display weergegeven. Als de accu is opgeladen, het netsnoer uit het stopcontact en uit het contact van de Invia Liberty trekken.

Sluit de elektrische uitgangspoort door het klepje omlaag te drukken.



OPMERKING

De negatieve druktherapie moet worden voortgezet tijdens het opladen van de accu van de pomp. Schakel de pomp niet uit tijdens het opladen.

Laad de accu altijd 's nachts op.

Elektrische aansluiting



Opvangpot verwisselen

Verwissel de opvangpot ten minste eenmaal per week, of als de opvangpot vol lijkt te zijn of als er een alarm wordt afgegeven, conform de instructies op de display van de pomp.

1 Was uw handen.

2 Druk op de "Stand-by"-knop [ > 3 seconden] waarna de pompmotor stopt met lopen.

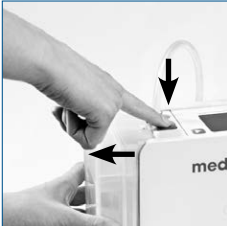
3  Druk op de ontgrendeling aan de bovenzijde van de pomp en verwijder de opvangpot.

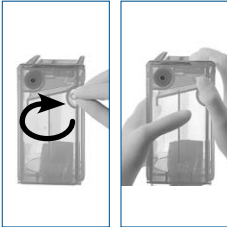
4  Sluit de gebruikte opvangpot af met de dop aan de zijkant van de opvangpot.

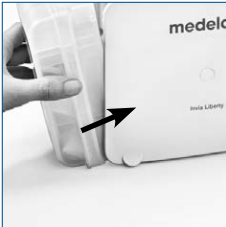
5  Open de verpakking van een nieuwe opvangpot en verwijder de veiligheidssticker, schuif eerst de palletjes aan de onderkant van de opvangpot in de uitsparingen aan de onderkant van de pomp. Til de opvangpot naar de Invia Liberty pomp toe tot deze vastklikt.



OPMERKING

Gebruik de Invia Liberty opvangpot niet als de steriele verpakking beschadigd is.



6



Schakel de Invia Liberty pomp in door op "Aan" [] te drukken om de therapie te hervatten en schuif de pomp in de draagtas.

- 7 Voer de gebruikte opvangpot af conform de instructies van uw professionele zorgverlener.

Quick-connector voor aan-/afsluiten

De Quick-connector kan voor een korte periode (tot 20 minuten) worden ontkoppeld tijdens het aan- en uitkleden en persoonlijke hygiëne. Gedurende deze tijd kan de pomp in de modus "Stand-by" met een interval van vijf minuten worden gezet, waarna het alarm "Stand-by modus" zal afgaan. Dit alarm kan vervolgens voor vijf minuten worden onderdrukt.

- 1 Was uw handen.
- 2 Sluit de klem van de opvangpotslang en sluit de klem van de verbandslang.
- 3 Druk op de "Stand-by"-knop [ > 3 seconden] waarna de pompmotor stopt met lopen.



4

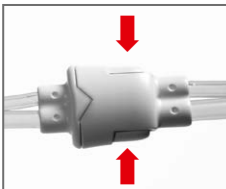

Haal de Quick-connector los door op de uiteinden van de connector te drukken.

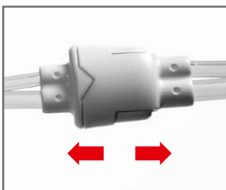

5

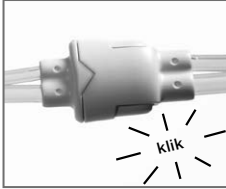
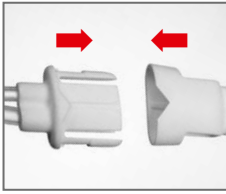

Duw de uiteinden van de Quick-connector samen tot er een klik te horen is om weer aan te sluiten.

6



Open de klem van de opvangpotslang en open de klem van de verbandslang.

7

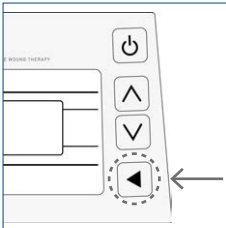

Druk op "Aan" [] om de therapie te hervatten.

Meldingen en problemen oplossen



Blijf rustig als er een geluidssignaal klinkt.
Volg de onderstaande instructies.

- 1 Als de Invia Liberty pomp in de draagtas zit, open de klep van de draagtas.
- 2 Druk op [] om het geluidssignaal voor 60 seconden te onderdrukken (hierop kan telkens worden gedrukt als het signaal wordt gegeven).

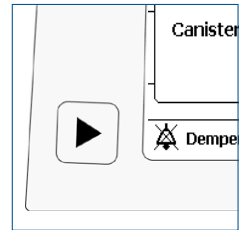

Tabel Alarmen

Waarschuwing	401	<p>Accu laag</p> <p>! 401</p> <p>Dempen Standby (3 sec.)</p>	<p>Accu laden</p> <p>! 401</p> <p>Dempen Standby (3 sec.)</p>	
	405	<p>Standby-modus</p> <p>! 405</p> <p>Dempen Aan</p>	<p>Zet pomp aan of uit</p> <p>! 405</p> <p>Dempen Aan</p>	
	406	<p>Interne temperatuur hoog</p> <p>! 406</p> <p>Dempen Standby (3 sec.)</p>	<p>Verwijder de pomp van de warmtebron (bv. rechtstreeks zonlicht) of maak de pomp vrij (verwijder bv. dekens).</p> <p>! 406</p> <p>Dempen Standby (3 sec.)</p>	
Alarm	301	<p>Lek in systeem</p> <p>!!! 301</p> <p>Dempen Standby (3 sec.)</p>	<p>Controleer verbanden op lekken en of de canister goed is aangesloten.</p> <p>!!! 301</p> <p>Dempen Standby (3 sec.)</p> <p>Raadpleeg IFU voor verdere instructies.</p>	
	302	<p>Systeem verstopt</p> <p>!!! 302</p> <p>Dempen Standby (3 sec.)</p>	<p>Controleer of de slang vrij en niet geknikt is. Controleer of de canister vol is.</p> <p>!!! 302</p> <p>Dempen Standby (3 sec.)</p> <p>Raadpleeg de gebruiksaanwijzing voor verdere instructies.</p>	

	Opmerkingen/mogelijke oorzaak van de fout
	<p>Laad de accu op door de Invia Liberty pomp in het laadstation te plaatsen of steek de stekker van de oplader in de elektrische poort op de pomp.</p> <p>De accu kan nog ongeveer 30 minuten worden gebruikt.</p>
	<p>Als de pomp gedurende langer dan vijf minuten in de Stand-by modus staat, wordt er een alarm afgegeven.</p> <p>Druk op "Aan" [] om de therapie te vervolgen.</p>
	<p>De Invia Liberty pomp volgens de instructies op de display laten afkoelen.</p>
	<p>Wondverband:</p> <ul style="list-style-type: none"> - Controleer het wondverband op luchtlekkage. Druk de randen van het wondverband, rondom de verbandslang of het Invia FitPad, stevig aan. - Breng eventueel extra filmverband aan om het lek te dichten. <p>Connectors:</p> <ul style="list-style-type: none"> - Zorg dat de verbandslang goed op de slang van de opvangpot is aangesloten. - Zorg dat de slang van de opvangpot recht op de pomp is aangesloten. <p>Opvangpot:</p> <ul style="list-style-type: none"> - Zorg dat de opvangpot goed is geplaatst, haal de opvangpot los en plaats deze weer terug. - Controleer of de oranje O-ring/pakking naast de opvangpotslang op de pomp niet ontbreekt. Een reserve O-ring is verkrijgbaar via een vertegenwoordiger van Medela.
	<p>Neem telefonisch contact op met uw professionele zorgverlener.</p>



Alarm	305			
	306			
	311			
	313			
Interne foutmelding				



OPMERKING

Als de symbolen op de display niet duidelijk zijn of als u het alarm op de display niet begrijpt, neem dan contact op met uw professionele zorgverlener.

Opmerkingen/mogelijke oorzaak van de fout	
	<p>Laad de accu op door de Invia Liberty pomp in het laadstation te plaatsen of steek de stekker van de oplader in de elektrische poort op de pomp.</p> <p>De accu kan nog ongeveer 15 minuten worden gebruikt.</p>
	<p>Vervang de opvangpot, raadpleeg het hoofdstuk "Opvangpot vervangen".</p>
	<p>Opvangpot: - Maak de opvangpot los en plaats hem weer terug. Slangen: - Zorg dat de slangen niet gedraaid, geknikt of vastgeklemd zijn.</p>
	<p>Vervang de opvangpot, raadpleeg het hoofdstuk "Opvangpot vervangen".</p>
	<p>Herstart de pomp. Als de interne fout niet verdwijnt, de pomp uitschakelen door te drukken op [ > 3 seconden] en contact opnemen met uw professionele zorgverlener.</p>



OPMERKING

Als de pomp niet meer werkt en niet meer kan worden ingeschakeld, onmiddellijk contact opnemen met uw professionele zorgverlener.

Reiniging/desinfectie



De Invia Liberty pomp kan met een vochtige doek met een mild huishoudelijk schoonmaakmiddel worden afgeveegd.

Garantie



De garantieperiode bedraagt 2 jaar vanaf de leverdatum.

De fabrikant is niet aansprakelijk voor enige schade of schade die voortvloeit uit onjuiste bediening, onjuist gebruik en gebruik door niet geautoriseerde personen.

Onderhoud / routinematige veiligheidscontrole



Onderhoudswerkzaamheden mogen uitsluitend door geautoriseerd personeel worden uitgevoerd. De veiligheidscontrole omvat een visuele inspectie van de behuizing en de oplader op beschadigingen en dient vóór elk gebruik te worden uitgevoerd. Als de Invia Liberty pomp niet gebruikt wordt, dient de accu ongeveer om de zes maanden te worden opgeladen om een optimale werking te garanderen.

Afvoer



Informeer bij uw professionele zorgverlener naar de wijze van afvoeren van gebruikte wondverbanden, opvangpotten en slangen.

Technische specificaties



Opslagvoorwaarden accessoires

De accessoires moeten in de verpakking bewaard worden bij een temperatuur tussen $-20\text{ }^{\circ}\text{C}$ en $+50\text{ }^{\circ}\text{C}$.

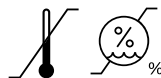

Omgevingsvoorwaarden tijdens het gebruik

De Invia Liberty pomp en accessoires moeten worden gebruikt bij een temperatuur tussen $+5\text{ }^{\circ}\text{C}$ en $+40\text{ }^{\circ}\text{C}$. Gebruik de producten niet bij extreme kou of hitte. Vermijd een hoge relatieve vochtigheid (15-93% is toelaatbaar).



OPMERKING

De Invia Liberty pomp niet gebruiken op een plek die hoger ligt dan 3000 m boven zeeniveau.

Beschermingsklasse IP33

De Invia Liberty pomp is beveiligd tegen het binnendringen van vaste deeltjes groter dan 2,5 millimeter en druiwater.

IP33



Pictogrammen en symbolen



Dit symbool wijst op een veiligheidstip (OPMERKING) of WAARSCHUWING met betrekking tot het apparaat.



Dit symbool geeft een hulpmiddel van classificatie II aan.



Het apparaat niet samen met ongesorteerd gemeentelijk afval afvoeren (geldt alleen in de EU).



Dit symbool geeft de productiedatum aan (vier cijfers voor het jaar en twee cijfers voor de maand).



Dit symbool geeft de naam en het adres van de fabrikant aan.



Dit symbool geeft aan dat het hulpmiddel door een arts moet worden voorgeschreven. **OPMERKING: VS:** volgens de federale wetgeving is de verkoop van dit hulpmiddel, of de opdracht daartoe, voorbehouden aan een arts (geldt alleen in de VS).



Dit symbool duidt op een toegepast onderdeel type BF.



Dit symbool geeft het catalogusnummer van de fabrikant aan.



Dit symbool geeft een serienummer van de fabrikant aan.



Dit symbool geeft een batchcode van de fabrikant aan.

STERILEEO

Dit symbool geeft aan dat het hulpmiddel met etheenoxide is gesteriliseerd.



Dit symbool geeft aan dat het hulpmiddel niet mag worden gebruikt na afloop van het getoonde jaar en maand.



Dit symbool geeft aan dat de gebruiksinstructies gevolgd moeten worden.



Dit symbool wijst op het naleven van aanvullende veiligheidsvoorschriften voor medische elektrische apparatuur in de VS en Canada.



Dit symbool waarschuwt ervoor het hulpmiddel niet te gebruiken indien de verpakking beschadigd is.

IP33

Dit symbool wijst op bescherming tegen het binnendringen van vreemde voorwerpen en tegen de schadelijke gevolgen van het binnendringen van water.



Dit symbool wijst erop dat het gemarkeerde artikel of het materiaal waarvan het is gemaakt, deel uitmaakt van een recycling- of hergebruikproces.



Dit symbool geeft de grenswaarde voor vochtigheid aan voor bedrijf en opslag.



Dit symbool geeft de grenswaarde aan voor de atmosferische druk tijdens bedrijf en opslag.



Dit symbool geeft aan dat het hulpmiddel niet nat mag worden.

pcs

Dit symbool geeft het aantal artikelen aan.



Dit symbool geeft het gelijkstroomcontact aan.



Dit symbool geeft aan dat het hulpmiddel voor eenmalig gebruik is bedoeld. Het hulpmiddel niet hergebruiken.



Dit symbool geeft de temperatuurgrenswaarde voor bedrijf, transport en opslag aan.



Dit symbool geeft aan dat het hulpmiddel uit het zonlicht moet worden gehouden.



Dit symbool wijst erop dat het hulpmiddel breekbaar is en zorgvuldig moet worden behandeld.



Dit symbool geeft aan dat het hulpmiddel voldoet aan Richtlijn 93/42/EEG inzake medische hulpmiddelen.



Dit symbool geeft de correcte positie (rechttop) van het transportpakket aan.

Elektromagnetische compatibiliteit (EMC)

De Invia Liberty is EMC-getest conform de eisen van IEC 60601-1-2:2007 en IEC 60601-1-2:2014 4e editie in overeenstemming met de bepalingen 7 en 8.9.



WAARSCHUWING

De Invia Liberty pomp mag niet naast of bovenop andere apparatuur worden gebruikt. Is het toch noodzakelijk apparatuur naast of op elkaar te plaatsen, controleer dan eerst of de Invia Liberty pomp in de betreffende opstelling normaal functioneert.



WAARSCHUWING

Gebruik alleen door de fabrikant gespecificeerde accessoires en door de fabrikant geleverde onderdelen ter vervanging van interne componenten. Het niet opvolgen van deze aanwijzing kan verhoogde emissies veroorzaken of de immuniteit van de Invia Liberty pomp aantasten.



WAARSCHUWING

EMC

HF (hoge frequentie)-chirurgische uitrusting, radionetwerken enz. kunnen de werking van het apparaat beïnvloeden en mogen niet samen met de Invia Liberty pomp worden gebruikt.

Hjälp

Läs hela bruksanvisningen innan du använder utrustningen.

Om du har några frågor angående ditt Invia Liberty-system för sårbehandling med negativt tryck ska du kontakta din vårdgivare/läkare via numret nedan:

VÅRDGIVARE/LÄKARE
KONTAKTINFORMATION:

Förvara denna patientbruksanvisning på en lättillgänglig plats.

Innehållsförteckning

Varningar, försiktighet och säkerhetsanvisningar	172
Allmänna varningar	172
Syftet med utrustningen	174
Avsedd användning	174
När ska utrustningen användas? (Bruksanvisning)	175
När ska utrustningen inte användas? (Kontraindikationer)	175
Beskrivning av utrustningen	176
Display	177
Förhållanden som påverkar användningen	177
Allmän säkerhet i hemmet	178
Under sömn	179
Dusch, bad och tvätt	179
När du lämnar hemmet	180
Anvisningar för iordningställande	180
Förbereda bärväskan	182
Ladda batteriet	182
Byta behållare	184
Anslut/koppla från snabbkopplingen	185
Meddelanden och felsökning	187
Larmtabell	188
Rengöring/desinficering	192
Garanti	192
Underhålls-/säkerhetsrelaterad kontroll	192
Avfallshantering	192
Tekniska specifikationer	193
Skyltar och symboler	194
Elektromagnetisk kompatibilitet (EMC)	197

Varningar, försiktighet och säkerhetsanvisningar

VARNING

Anger en potentiellt farlig situation som om den inte upphävs kan resultera i dödsfall eller allvarliga skador.

FÖRSIKTIGHET

Anger en potentiellt farlig situation som kan resultera i mindre eller lindriga skador.

Allmänna varningar

VARNING

Personen som ansvarar för användning av utrustningen på daglig basis (patient, vårdpersonal) måste kunna läsa, förstå och följa informationen i den här bruksanvisningen och informationen från vårdpersonalen. Personen måste kunna höra och reagera på ljudsignaler.

Använd endast Invia Liberty NPWT-systemet på personer som har ordinerats det och endast enligt avsedd användning.

Genomför aldrig behandlingen utan att först ha rådfrågat vårdpersonal och vårdgivare som har god kunskap om bruksanvisningen, och heller aldrig utan överinseende från vårdpersonal.

Modifiering av utrustningen är inte tillåtet.

VARNING

Gör frekventa visuella kontroller av sårförbandet och Invia Liberty-systemet.

Om du ser stora mängder blod i förbandet, slangen eller behållaren:

- 1 Stäng av pumpen genom att hålla  intryckt i 3 sekunder.
- 2 Tryck mot såret.
- 3 Sök omedelbart medicinsk hjälp.



Om du får svårt att andas ska du omedelbart söka medicinsk hjälp.

VARNING

Kontakta vårdpersonal omedelbart om du upplever något eller flera av följande symptom:

- Starkt nedsatt syn eller hörsel
- Smärta, ömhet eller rodnad runt såret
- Svullnad, klåda eller utslag runt såret
- Feber
- Stark lukt från såret
- Tjock, grön dränerad vätska eller avvikande färg på den dränerade vätskan
- Illamående, kräkningar eller diarré
- Halsont med svullnad
- Yrsel eller förvirring
- Allergiska reaktioner som rodnad, utslag eller nässelfeber, svullnad eller svår klåda

VARNING

När vårdpersonalen har ställt in pumpptrycket och behandlingstiden ska du inte trycka på någon annan knapp än strömbrytaren [], standbyknappen [] eller knappen för tyst läge [].

VARNING

Pumpen måste användas 24 timmar om dygnet. Stoppa aldrig pumpen såvida du inte har fått instruktioner om att göra det från vårdpersonalen eller om omfattande blödning uppstår. Om pumpen stoppas i mer än 2 timmar måste förbandet bytas. Kontakta omedelbart vårdpersonalen för att be om ett förbandsbyte.

VARNING

Om pumpen slutar fungera och inte går att starta igen ska du omedelbart kontakta vårdpersonalen.

Syftet med utrustningen

Din vårdgivare har ordinerat sårbehandling med negativt tryck (NPWT) för dig.

Sårbehandling med negativt tryck har visat sig bidra till främjandet av läkning av flera olika sårtyper. Negativt tryck (sugning) appliceras på ett sår via en pump. Sugningen, eller det negativa trycket, bidrar till att avlägsna vätska och försluta såret.

Vårdpersonalen kommer att placera ett särskilt förband på ditt sår och en slang kommer att anslutas från ditt sår till pumpens behållare. Därefter startas pumpen med det ordinerade trycket i syfte att avlägsna vätska från ditt sår. Vätskan samlas upp i behållaren. Behandlingen pågår 24 timmar om dygnet.

Avsedd användning

Avsedd användare

Invia Liberty NPWT-systemet är avsett att användas av vårdpersonal eller av lekmän med adekvat utbildning.

Vårdpersonal ansvarar för att lära upp lekmän i enlighet med bruksanvisningen samt att förklara all relaterad säkerhetsinformation.

Avsedd patientgrupp

Invia Liberty NPWT-systemet är avsett att användas endast på patienter som uppvisar de tillstånd som beskrivs i bruksanvisningen. Utrustningen har inte studerats vid behandling av barn.

Avsedd miljö

Invia Liberty NPWT-systemet är avsett för användning vid akut eller långvarig sjukhusbehandling och i hemvårdsmiljö.

När ska utrustningen användas?

(Bruksanvisning)

Invia Liberty NPWT-systemet är avsett för patienter som kan dra nytta av en sugenhet (sårbehandling med undertryck) eftersom det främjar sårhäkning genom sekundär eller tertiär (fördröjd primär) intention genom att förbereda sårbedden för stängning, minska ödem, främja bildandet av granulationsväv och genomblödning, och genom att ta bort utsöndringar och smittsamma kroppsvätskor. När Invia Liberty NPWT-systemet används på stängda kirurgiska snitt är det också avsett för att hantera miljön kring kirurgiska snitt som fortsätter att avge vätska efter stängning med suturer eller agraffer genom att det upprätthåller en sluten miljö och avlägsnar exsudat via applicering av sårbehandling med negativt tryck (NPWT).

Invia Liberty NPWT-systemet är lämpligt vid följande indikationer:

- Akuta eller subakuta sår
- Kroniska sår
- Öppna sår
- Trycksår
- Diabetessår/neuropatiska sår
- Bensår
- Traumasår
- Andra gradens brännskador
- Lambåer och transplanterat
- Stängda kirurgiska snitt

När ska utrustningen inte användas?

(Kontraindikationer)

The Invia Liberty NPWT-systemet är kontraindicerat vid förekomst av:

- Nekrotisk vävnad med sårskorpa
- Obehandlad osteomyelit
- Icke-tarmrelaterade och outredda fistlar
- Maligna sår
- Exponerade blodkärl
- Exponerade nerver
- Exponerat anastomotiskt område av blodkärl eller förbikopplingar av kärl
- Exponerade organ

Om du har några funderingar ska du prata med vårdpersonalen.

Beskrivning av utrustningen

Kontrollera att Invia Liberty-systemets förpackning är komplett och i gott skick.



VARNING

Använd inga andra tillbehör än de som beskrivs nedan.

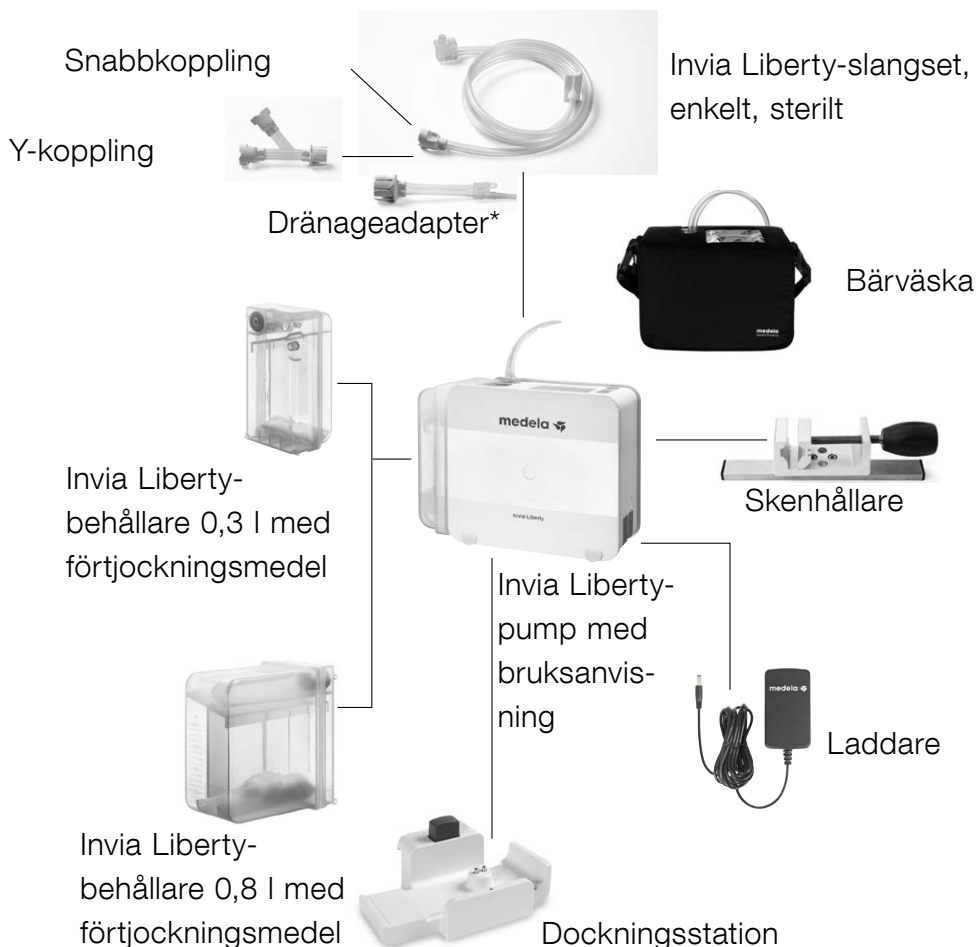

*Produkten är inte tillgänglig i alla länder

Display

Knappar för manövrering av Invia Liberty-pumpen

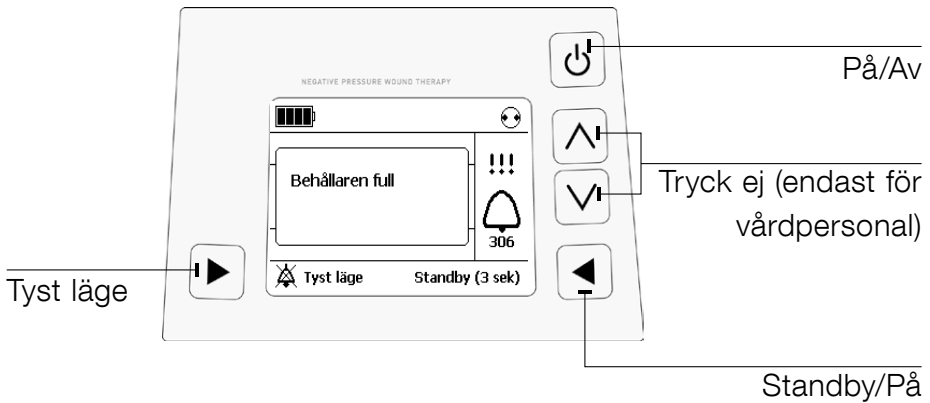

Förhållanden som påverkar användningen



FÖRSIKTIGHET

Invia Liberty-pumpen måste stå upprätt under drift.





Vi ber dig läsa och iaktta dessa varningstexter och säkerhetsanvisningar före användning. Denna bruksanvisning måste sparas tillsammans med utrustningen. Observera att denna bruksanvisning endast ger allmänna anvisningar om hur produkten används. Medicinska frågor ska alltid hanteras av läkare.



FÖRSIKTIGHET/VARNING

- Använd inte förlängningssladdar i kombination med Invia Liberty-pumpen.
- Placera elkabeln på ett sätt så att ingen kan snubbla över den.
- Dra aldrig elkabeln runt halsen.
- Se till att elkabeln inte kommer i kontakt med varma ytor.
- Dra aldrig ut stickkontakten ur väggkontakten genom att dra i elkabeln.
- Försök inte laga Invia Liberty-pumpen. Kontakta vårdpersonal om pumpen inte fungerar.
- Håll Invia Liberty-pumpen ren och torr.
- Ställ aldrig Invia Liberty-pumpen i vatten eller i andra vätskor.
- Torka Invia Liberty-pumpen med en handduk om den blir blöt.
- Torka inte Invia Liberty-pumpen i mikrovågsugn.
- Håll Invia Liberty-pumpen utom räckhåll för barn och husdjur.
- Övervakning krävs när Invia Liberty-pumpen användas i miljöer där barn finns i närheten.
- Skydda Invia Liberty-pumpen mot direkt solljus.
- Explosionsrisk – Invia Liberty-pumpen får inte användas i potentiellt explosiva miljöer, inklusive syreberikade miljöer, eller i områden med lättantändliga anestetika.
- Utrustning för trådlös kommunikation så som enheter för trådlösa hemnätverk, mobiltelefoner, sladdlösa telefoner och deras basenheter samt walkie-talkies kan störa Invia Liberty-pumpens funktion och ska vara placerade minst 30 cm från Invia Liberty-pumpen. Detta kan orsaka otillräcklig laddning av batteriet eller

leda till ett internt fel. Se kapitlet ”Meddelande och felsökning för åtgärder att vidta i händelse av ett internt fel”.

- Denna produkt innehåller litiumjonbatterier vilket medför en risk för brand, explosioner och brännskador. Får inte tas isär, krossas, värmas upp till över 100 °C, förbrännas eller slängas i eld.

Om du upptäcker att vakuumnivån har förändrats eller något feltillstånd ska du placera Invia Liberty-pumpen på minst 30 cm avstånd från mobiltelefonen när du ringer eller besvarar samtal. Stäng av och starta Invia Liberty-pumpen för att återställa den efter ett feltillstånd. När så är möjligt rekommenderas ett säkerhetsavstånd på minst 30 cm mellan Invia Liberty-pumpen och en mobiltelefon.

Under sömn



- Kontrollera att Invia Liberty-pumpens slang inte kan bli veckad eller böjd.
- Kontrollera att Invia Liberty-pumpen inte kan falla ned när du sover.
- Ladda alltid Invia Liberty-pumpen när du lägger dig.

Dusch, bad och tvätt



- Använd inte Invia Liberty-pumpen medan du badar eller duschar.
- Invia Liberty-pumpen kan kopplas från förbandet under en kortare tid (upp till 20 minuter) om du behöver byta kläder, duscha eller tvätta dig. Berätta för vårdpersonalen när du behöver duscha eller liknande.
- Förhindra att Invia Liberty-pumpen blir våt.
- Placera inte Invia Liberty-pumpen på en plats där den kan falla ned i en dusch, ett handfat eller ett badkar.
- Rör inte vid Invia Liberty-pumpen om den har fallit ned i vatten. Dra genast ut elkabeln från vägguttaget och koppla från pumpen från förbandet.

När du lämnar hemmet



- Kontrollera batteriets status och ladda det om det behövs innan du lämnar hemmet.
- En bekväm lösning är att placera Invia Liberty-pumpen i bärväskan.
- Glöm inte att ta med en extra behållare och strömssladden.

Anvisningar för iordningställande



VARNING

Kontrollera Invia Liberty-pumpen och förbandet ofta för att säkerställa att de fungerar. Gör visuella kontroller av sårförbandet, området runt såret och vätskan i behållaren för att se om det finns tecken på infektion eller andra komplikationer som vårdpersonalen har informerat dig om.

Starta

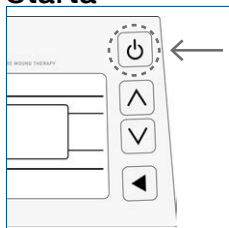

Starta Invia Liberty-pumpen genom att trycka på [].

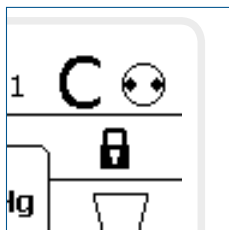

Displayens utseende när pumpen är igång. Drift-/standbyindikatorn roterar [].



VARNING

Försök aldrig genomföra behandlingen utan överinseende av vårdpersonal.



VARNING

NPWT-behandlingen måste pågå 24 timmar om dygnet. Avbryt aldrig behandlingen såvida du inte har fått instruktioner om att göra det från vårdpersonalen eller om omfattande blödning uppstår.



VARNING

Om behandlingen avbryts i mer än 2 timmar ska förbandet bytas och behandlingen startas om av vårdpersonal.



VARNING

Invia Liberty-pumpen känner inte av blockeringar i den slang som är ansluten till dränageadaptorn eller till den böjda armen på Y-kopplingen. Kontrollera därför förbandsslangen som är ansluten till dränageadaptorn eller den böjda armen på Y-kopplingen ofta under dagen för att säkerställa att slangen inte är veckad eller blockerad.

Om du upptäcker en blockering i den slang som är ansluten till dränageadaptorn eller till den böjda armen på Y-kopplingen ska du kontakta vårdpersonalen.

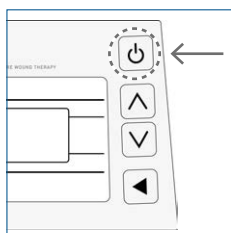

Stänga av

Stäng av Invia Liberty-pumpen genom att hålla [] intryckt i 3 sekunder.

Tryck bara en gång.

Förbereda bärväskan

Invia Liberty-pumpen är avsedd att bäras i en bärväska samtidigt som den används.



- 1 Öppna bärväskan.
- 2 Placera Invia Liberty-pumpen i det avsedda facket.
- 3 Stäng facket med kardborrelåset.

Axelremmen kan även användas som bältesrem.

För att ändra till bältesläge lossar du remmen på sidorna om bärväskan och för den genom de två öglorna på bärväskans baksida.

Ladda batteriet

När batteriet är fulladdat har det i allmänhet en driftstid på över 14 timmar. Om Invia Liberty-pumpen körs kontinuerligt på grund av ett luftläckage kan batteriet behöva laddas tidigare.

Batteristatussymboler



fullt

halvfullt

helt urladdat (tomt)

Om batteriet blir helt urladdat (tomt) ska du följa instruktionerna nedan.

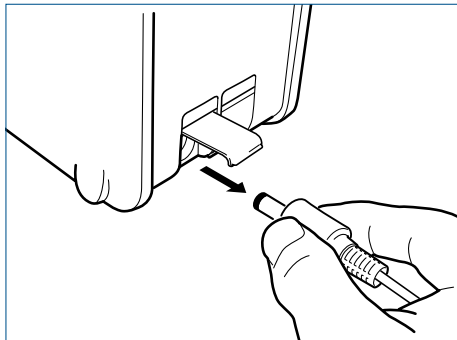

Öppna eluttagsporten. Anslut Invia Liberty-pumpen till kontakten på elsladden som medföljer pumpen. Anslut den andra änden av strömladden till ett vägguttag. När batteriet laddas visas rörliga streck på batteridisplayen.

Batteriet är fulladdat efter cirka 4 timmar. När batteriet är fulladdat och pumpen fortfarande är ansluten till strömkällan visas  konstant på displayen. När laddningen är slutförd drar du ut elkontakten ur vägguttaget och kopplar från Invia Liberty-pumpen från strömladden.

Stäng eluttagsporten genom att trycka ned skyddslocket.



FÖRSIKTIGHET

NPWT-behandlingen måste fortskrida medan pumpens batteri laddas. Stäng inte av pumpen under laddningen.

Ladda alltid batteriet över natten.

Nätadapterport



Byta behållare

Byt behållare minst en gång i veckan, när behållaren verkar full eller när larmet ljuder, i enlighet med instruktionerna på pumpens display.

1 Tvätta händerna.

2 Tryck på knappen "Standby" [ > 3 sekunder] och pumpens motor stoppas.

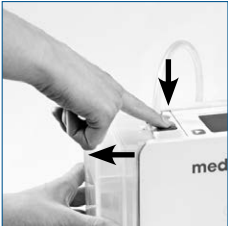
3  Tryck på frigöringsknappen högst upp på pumpen och ta bort behållaren.

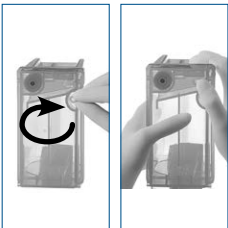
4  Stäng den använda behållaren med det lock som sitter på sidan av behållaren.

5  Ta ut den nya behållaren ur förpackningen och ta bort säkerhetsetiketten. För in spritarna på behållarens undersida i spåren längst ned på pumpen. Tryck behållaren uppåt och klicka fast den i Invia Liberty-pumpen.



FÖRSIKTIGHET

Använd inte en Invia Liberty-behållare om den sterila förpackningen är skadad.

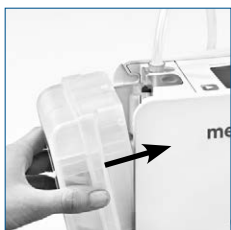

6



Starta Invia Liberty-pumpen genom att trycka på "På" [◀] för att återuppta behandlingen och placera pumpen i bärväska.

7 Kassera den använda behållaren i enlighet med anvisningarna du har fått från vårdpersonalen.

Anslut/koppla från snabbkopplingen

Snabbkopplingen kan kopplas från under en kortare tid (upp till 20 minuter) om du behöver byta kläder, duscha eller tvätta dig. Under denna tid kan pumpen försättas i standbyläge i 5-minutersintervall. Efter varje intervall avges larmet "standbyläge", som kan tystas i ytterligare 5 minuter.

- 1 Tvätta händerna.
- 2 Stäng klämman på behållarens slang och stäng sedan klämman på förbandets slang.
- 3 Tryck på knappen "Standby" [◀ > 3 sekunder] och pumpens motor stoppas.



4

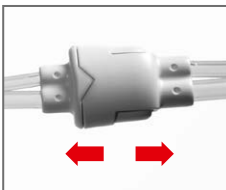
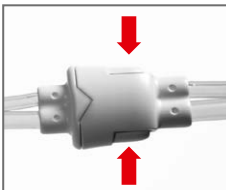

Koppla från snabbkopplingen genom att trycka under båda sidorna av kopplingen.

5

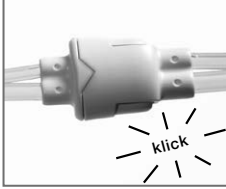
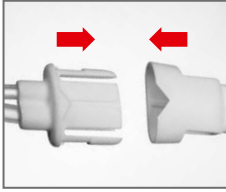

Anslut snabbkopplingen igen genom att trycka på snabbkopplingen tills du hör att det klickar.

6



Öppna klämman på behållarens slang och öppna sedan klämman på förbandets slang.

7

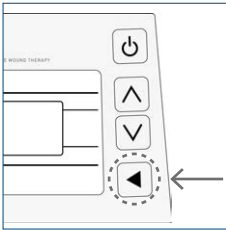

Tryck på "På" [] för att återuppta behandlingen.

Meddelanden och felsökning



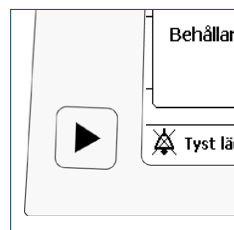

Drabbas inte av panik om du hör en ljudsignal.
Följ instruktionerna nedan.

- 1 Om Invia Liberty-pumpen är placerad i bärväskan öppnar du locket på bärväskan.
- 2 Tryck på [] för att tysta ljudsignalen i 60 sekunder (kan tryckas in varje gång signalen ljuder).

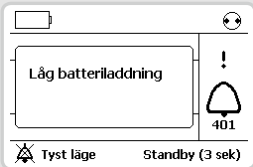
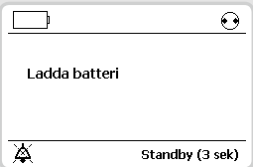

Larmtabell

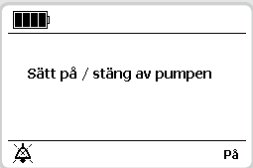
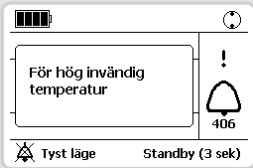
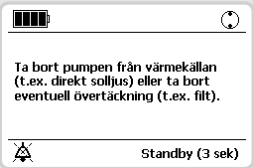
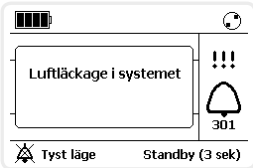
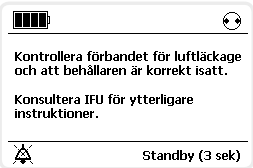
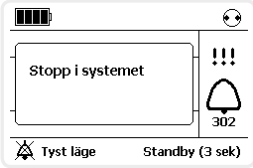
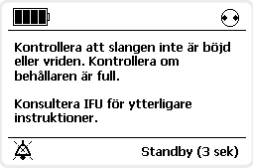
Varning	401	 <p>Låg batteriladdning</p> <p>401</p> <p>Tyst läge Standby (3 sek)</p>	 <p>Ladda batteri</p> <p>Standby (3 sek)</p>
	405	 <p>Standbyläge</p> <p>405</p> <p>Tyst läge På</p>	 <p>Sätt på / stäng av pumpen</p> <p>På</p>
	406	 <p>För hög invändig temperatur</p> <p>406</p> <p>Tyst läge Standby (3 sek)</p>	 <p>Ta bort pumpen från värmekällan (t.ex. direkt solljus) eller ta bort eventuell övertäckning (t.ex. filt).</p> <p>Standby (3 sek)</p>
Larm	301	 <p>Luftläckage i systemet</p> <p>301</p> <p>Tyst läge Standby (3 sek)</p>	 <p>Kontrollera förbandet för luftläckage och att behållaren är korrekt isatt.</p> <p>Konsultera IFU för ytterligare instruktioner.</p> <p>Standby (3 sek)</p>
	302	 <p>Stopp i systemet</p> <p>302</p> <p>Tyst läge Standby (3 sek)</p>	 <p>Kontrollera att slangens inte är böjd eller vriden. Kontrollera om behållaren är full.</p> <p>Konsultera IFU för ytterligare instruktioner.</p> <p>Standby (3 sek)</p>

Anmärkingar/möjlig felorsak

Ladda batteriet genom att antingen placera Invia Liberty-pumpen i dockningsstationen eller ansluta laddaren till pumpens nätadapterport.

Återstående batteritid är cirka 30 min.

Om pumpen är i standbyläge i mer än 5 minuter utlöses ett larm.

För att fortsätta behandlingen trycker du på "På" [].

Kyl ned Invia Liberty-pumpen enligt instruktionerna på displayen.

Förband:

- Kontrollera förbandet med avseende på luftläckage. Tryck till förbandet ordentligt runt kanterna, runt dränageslangen eller på Invia FitPad.
- Applicera eventuellt mer förbandsfilm för att försegla läckan.

Kopplingar:

- Säkerställ att sårförbandets slang är korrekt ansluten till behållarens slang.
- Säkerställ att behållarens slang är direkt ansluten till pumpen.

Behållare:

- Säkerställ att behållaren är korrekt ansluten, koppla loss behållaren och justera den.
- Säkerställ att den orangea O-ringen/packningen som är placerad bredvid behållarens slang på pumpen är på plats. Extra O-ringar kan beställas via en Medela-representant.

Ring vårdpersonal.

Larm	305		
	306		
	311		
	313		
Internt fel			



FÖRSIKTIGHET

Om du inte vet vad en symbol betyder eller om du inte förstår det larm som visas på displayen ska du kontakta vårdpersonalen.

Anmärkningar/möjlig felorsak	
	Ladda batteriet genom att antingen placera Invia Liberty-pumpen i dockningsstationen eller ansluta laddaren till pumpens nätadapterport. Återstående batteritid är cirka 15 minuter.
	Byt behållare. Se kapitlet "Byta behållare".
	Behållare: - Koppla loss behållaren och justera. Slang: - Säkerställ att slangarna inte har vridit sig eller är böjda eller klämda.
	Byt behållare. Se kapitlet "Byta behållare".
	Starta om pumpen. Om det interna felet kvarstår stänger du av pumpen genom att trycka på [ > 3 sekunder] och kontakta vårdpersonal.



VARNING

Om pumpen slutar fungera och inte går att starta igen ska du omedelbart kontakta vårdpersonalen.

Rengöring/desinficering



Invia Liberty-pumpen kan torkas av med en fuktig trasa och ett mildt rengöringsmedel för hushållsbruk.

Garanti



Garantitiden är 2 år från leveransdatum. Tillverkaren är inte ansvarig för skador eller följdskador som orsakas av felaktigt handhavande, felaktig användning eller bruk av icke auktoriserad person.

Underhålls-/säkerhetsrelaterad kontroll



Servicearbete får endast utföras av behörig personal.

Den säkerhetsrelaterade kontrollen är begränsad till en visuell inspektion av höljet och laddaren med avseende på eventuella skador och måste utföras före varje användningstillfälle. Om Invia Liberty-pumpen inte har använts måste batteriet laddas ungefär var sjätte månad för att optimal funktion ska kunna garanteras.

Avfallshantering



Rådfråga vårdpersonalen om hur du ska kassera förband, behållare och slangar.

Tekniska specifikationer



Förvaringsvillkor för tillbehör

Tillbehör måste förvaras i förpackningen vid en temperatur på mellan -20 °C och +50 °C.



Miljövillkor för användning

Invia Liberty-pumpen och dess tillbehör ska användas inom ett temperaturområde på mellan +5 °C och +40 °C. Använd inte produkterna vid extrem kyla eller värme. Undvik hög relativ luftfuktighet (15–93 % är tillåtet).



FÖRSIKTIGHET

Använd inte Invia Liberty-pumpen om du befinner dig mer än 3 000 meter över havet.

Skyddsklass IP33

IP33

Invia Liberty-pumpen är skyddad mot inträngande av fasta främmande föremål större än 2,5 millimeter och mot vattendroppar.

Skyltar och symboler



Symbolen anger FÖRSIKTIGHET eller VARNING som är förknippad med utrustningen.



Symbolen anger en klass II-utrustning.



Utrustningen får inte kasseras tillsammans med osorterat hushållsavfall (gäller endast inom EU).



Symbolen anger tillverkningsdatum (fyra siffror för året och två siffror för månaden).



Symbolen anger tillverkarens namn och adress.



Symbolen anger att denna utrustning är receptbelagd. FÖRSIKTIGHET: Enligt federala lagar i USA får utrustningen endast säljas av eller på uppdrag av medicinsk personal (gäller endast i USA).



Symbolen anger att delen är säkerhetsklassad som typ BF.



Den här symbolen visar tillverkarens katalognummer.



Symbolen anger tillverkarens serienummer.



Symbolen anger tillverkarens batchnummer.

STERILE|EO

Symbolen anger att utrustningen är steriliserad med etylenoxid.



Symbolen anger att utrustningen inte får användas efter angivet år och angiven månad.



Symbolen anger att bruksanvisningen ska följas.



Symbolen anger att utrustningen uppfyller säkerhetsbestämmelser som gäller i USA och Kanada för medicinsk utrustning.



Symbolen anger att utrustningen inte ska användas om förpackningen är skadad.

pcs

Symbolen anger antalet ingående delar.

IP33

Symbolen anger skydd mot inträngande av fasta främmande föremål och mot skadliga effekter på grund av inträngande vatten.



Symbolen anger att det märkta föremålet eller dess material är en del av en återvinningsprocess.



Symbolen anger luftfuktighetsbegränsningar för drift och förvaring.



Symbolen anger de atmosfäriska tryckbegränsningarna för drift och förvaring.



Symbolen anger att utrustningen ska hållas torr.



Symbolen anger att utrustningen ska skyddas mot solljus.



Symbolen anger uttag för likström.



Symbolen anger en engångsutrustning. Återanvänd inte utrustningen.



Symbolen anger temperaturbegränsningarna för drift, transport och förvaring.



Symbolen anger att utrustningen ska hanteras varsamt.



Symbolen anger att utrustningen uppfyller de grundläggande kraven i rådets direktiv 93/42/EEG om medicinsk utrustning.



Symbolen anger den korrekta upprätta riktningen för transportförpackningen.

Elektromagnetisk kompatibilitet (EMC)

Invia Liberty är EMC-testad i enlighet med kraven i IEC 60601-1-2:2007 och IEC 60601-1-2:2014, fjärde upplagan enligt artikel 7 och 8.9.



VARNING

Invia Liberty-pumpen får inte användas i närheten av eller staplas på annan utrustning. Om Invia Liberty-pumpen måste användas i närheten eller på annan utrustning ska den övervakas för att kontrollera att den fungerar normalt i den aktuella konfigurationen.



VARNING

Använd inte andra tillbehör än de som anges här eller säljs av tillverkaren som reservdelar för inre delar. Det kan leda till ökad utströmning eller försämrad immunitet hos Invia Liberty-pumpen.



VARNING

EMC

Högfrekvent kirurgisk utrustning, radionätverk och liknande kan påverka utrustningens funktion och får inte användas i kombination med Invia Liberty-pumpen.

Assistenza

Leggere l'intero manuale di istruzioni prima di provare a mettere in funzione il dispositivo.

Per qualsiasi domanda sul sistema NPWT Invia Liberty, contattare il proprio assistente sanitario/medico al seguente numero:

ASSISTENTE SANITARIO/MEDICO
DATI DI CONTATTO:

Conservare il presente libretto delle istruzioni in un luogo facilmente accessibile.

Indice

Avvertenze, precauzioni e istruzioni di sicurezza	200
Avvertenze generali	200
Finalità del dispositivo	202
Uso previsto	202
Quando utilizzare il dispositivo (Indicazioni per l'uso)	203
Quando non utilizzare il dispositivo (Controindicazioni)	203
Descrizione del dispositivo	204
Display	205
Condizioni che interferiscono con l'uso	205
Procedure di sicurezza generali in casa	206
Durante il sonno	207
Doccia, bagno e igiene personale	207
Prima di uscire di casa	208
Istruzioni per la configurazione	208
Montaggio della borsa per il trasporto	210
Carica della batteria	210
Cambiare il contenitore	212
Collegare/scollegare il connettore rapido	213
Notifiche e risoluzione di problemi	215
Tabella Allarme	216
Pulizia/Disinfezione	220
Garanzia	220
Manutenzione/controllo di sicurezza	220
Smaltimento	220
Dati tecnici	221
Segni e simboli	222
EMC (compatibilità elettromagnetica)	225

Avvertenze, precauzioni e istruzioni di sicurezza

AVVERTENZA

Indica una situazione potenzialmente pericolosa che, se non evitata, può condurre alla morte o a gravi lesioni.

ATTENZIONE

Indica una situazione potenzialmente pericolosa che, se non evitata, può condurre a lesioni moderate o lievi.

Avvertenze generali

AVVERTENZA

La persona responsabile della messa in funzione giornaliera del dispositivo (paziente, assistente) deve essere in grado di leggere, capire e osservare le direttive riportate nelle presenti istruzioni per l'uso, sul display dell'aspiratore e le direttive del medico. Tale persona deve essere in grado di udire e rispondere a segnali acustici.

Utilizzare il sistema NPWT Invia Liberty solo sulla persona per cui è stata prescritta ed esclusivamente per l'uso previsto.

Non praticare la terapia senza aver prima consultato il personale sanitario e gli assistenti esperti nelle istruzioni per l'uso e senza la supervisione dell'operatore sanitario.

Non sono consentite modifiche all'apparecchio.

AVVERTENZA

Controllare visivamente e frequentemente la medicazione della ferita e il sistema Invia Liberty.

Se viene rilevata una grande quantità di sangue sulla medicazione, nel tubo o nel contenitore:

- 1 Spegnerne l'aspiratore tenendo premuto  per 3 secondi.
- 2 Applicare la pressione sulla ferita.
- 3 Cercare immediatamente assistenza medica d'emergenza.

Se si ha difficoltà a respirare, cercare immediatamente assistenza medica d'emergenza.



AVVERTENZA

Contattare immediatamente l'operatore sanitario se appare uno dei seguenti sintomi:

- perdita uditiva e visiva significativa;
- dolore, irritazione o arrossamento attorno alla ferita;
- gonfiore, prurito o eruzione cutanea attorno alla ferita;
- febbre;
- forte odore proveniente dalla ferita;
- drenaggio denso verde o qualsiasi altro cambiamento inusuale nel colore di drenaggio;
- nausea, vomito o diarrea;
- mal di gola con gonfiore;
- vertigini o confusione;
- reazioni allergiche come arrossamento, eruzione cutanea o orticaria, gonfiore o forte prurito.



AVVERTENZA

Dopo che l'operatore sanitario ha impostato la pressione dell'aspiratore e la modalità di funzionamento, non premere altri pulsanti salvo il pulsante Acceso/Spento, [⏻], il pulsante Standby [◀] o il pulsante Muto [▶].



AVVERTENZA

L'aspiratore deve essere utilizzato 24 ore al giorno. Non spegnere l'aspiratore salvo diverse istruzioni da parte dell'operatore sanitario o in caso di sanguinamento eccessivo.

Se l'aspiratore viene arrestato per più di 2 ore, la medicazione deve essere sostituita. Contattare l'operatore sanitario per richiedere la sostituzione della medicazione.



AVVERTENZA

Se l'aspiratore smette di funzionare e non si accende, contattare immediatamente l'operatore sanitario.

Finalità del dispositivo

Il medico (operatore sanitario) ha prescritto la terapia a pressione negativa per le ferite (NPWT).

È stato dimostrato che la terapia a pressione negativa per le ferite favorisce la guarigione di diversi tipi di ferite. La pressione negativa (aspirazione) viene erogata tramite un aspiratore sulla ferita.

L'aspirazione, o pressione negativa, aiuta a rimuovere il fluido e a far rimarginare la ferita. L'operatore sanitario posizionerà una speciale medicazione sulla ferita e un tubo passerà dalla ferita al contenitore nell'aspiratore. L'aspiratore viene quindi acceso alla pressione prescritta per rimuovere il fluido dalla ferita. Il fluido viene raccolto nel contenitore. Il trattamento dovrà essere effettuato 24 ore al giorno.

Uso previsto

Utente destinatario

Il sistema NPWT Invia Liberty è destinato all'uso da parte di operatori sanitari o di utenti inesperti adeguatamente formati.

Gli operatori sanitari sono responsabili di formare gli utenti inesperti in conformità alle istruzioni per l'uso per i pazienti e di fornire loro tutte le informazioni relative alla sicurezza.

Categoria di pazienti destinatari

Il sistema NPWT Invia Liberty è destinato all'uso su pazienti che presentano esclusivamente le condizioni descritte nelle indicazioni per l'uso. Il dispositivo non è stato studiato su pazienti pediatrici.

Ambiente destinatario

Il sistema NPWT Invia Liberty è destinato all'uso per trattamenti intensivi o prolungati in ambiente ospedaliero o domiciliare.

Quando utilizzare il dispositivo

(Indicazioni per l'uso)

Il sistema NPWT Invia Liberty è destinato a pazienti che potrebbero trarre vantaggio da un dispositivo di aspirazione (terapia a pressione negativa per le ferite), poiché crea un ambiente capace di favorire la guarigione delle ferite per intenzione secondaria o terziaria (primaria ritardata), preparando la sede della ferita per la rimarginazione, riducendo l'edema, promuovendo la formazione di tessuto di granulazione e la perfusione, oltre che rimuovere l'essudato e il materiale infetto. Nelle incisioni chirurgiche chiuse, il sistema NPWT Invia Liberty è concepito per gestire le incisioni chirurgiche che continuano a drenare dopo chiusura mediante sutura o pinzatura, mantenendo un ambiente chiuso e rimuovendo l'essudato tramite l'applicazione della terapia a pressione negativa per le ferite.

Il sistema NPWT Invia Liberty è idoneo per le indicazioni specificate di seguito:

- ferite acute o subacute;
- ferite croniche;
- ferite deiscenti;
- ulcere da pressione;
- ulcere diabetiche/neuropatiche;
- ulcere da insufficienza venosa;
- ferite traumatiche;
- ustioni a spessore parziale;
- lembi e innesti;
- incisioni chirurgiche chiuse.

Quando non utilizzare il dispositivo

(Controindicazioni)

Il sistema NPWT Invia Liberty è controindicato in presenza di:

- tessuto necrotico con presenza di escara;
- osteomielite non trattata;
- fistole non enteriche e non esplorate;
- neoplasia nella ferita;
- vasi esposti;
- nervi esposti;
- sito anastomotico esposto di vasi sanguigni o bypass;
- organi esposti.

In caso di problemi, consultare l'operatore sanitario.

Descrizione del dispositivo

Verificare la completezza e le condizioni generali del contenuto della confezione del sistema Invia Liberty.



AVVERTENZA

Non utilizzare accessori diversi da quelli descritti di seguito.

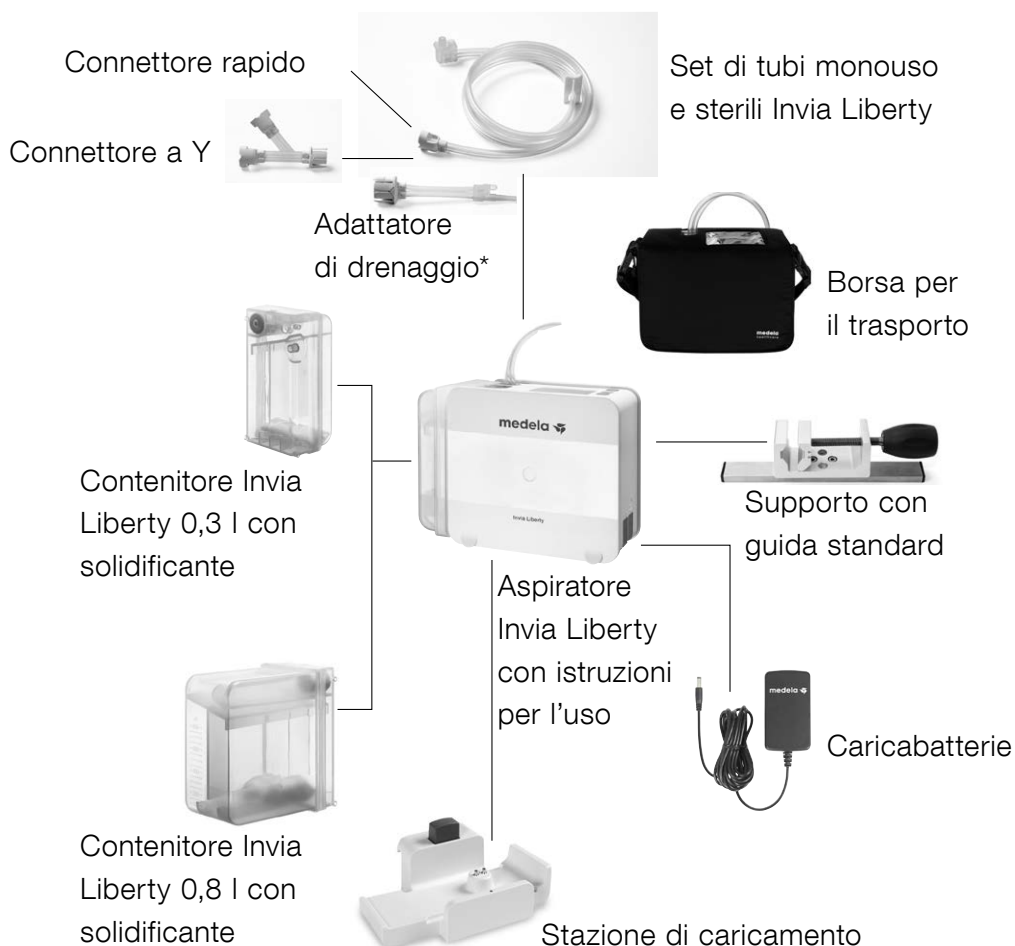

*Prodotto non disponibile in tutti i Paesi

Display

Pulsanti per il funzionamento dell'aspiratore Invia Liberty

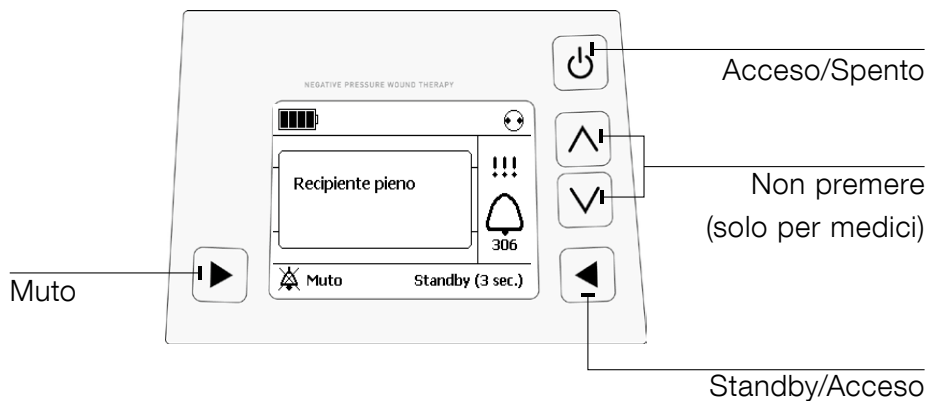

Condizioni che interferiscono con l'uso



ATTENZIONE

L'aspiratore Invia Liberty deve rimanere in posizione verticale durante l'uso.



Procedure di sicurezza generali in casa



Leggere e osservare le seguenti avvertenze e istruzioni di sicurezza prima dell'utilizzo. Conservare le istruzioni per l'uso insieme al dispositivo. Le presenti istruzioni per l'uso costituiscono una guida generale per l'impiego del prodotto. Per qualsiasi situazione medica rivolgersi a un medico.



ATTENZIONE/AVVERTENZE

- Non utilizzare cavi di prolunga con l'aspiratore Invia Liberty.
- Posizionare il cavo di alimentazione dove non possa causare cadute o inciampi.
- Non avvolgere mai il cavo di alimentazione attorno al collo.
- Tenere il cavo di alimentazione lontano da superfici calde.
- Non scollegare il cavo di alimentazione dalla presa del muro tirando il cavo.
- Non tentare di aggiustare o riparare l'aspiratore Invia Liberty. Contattare l'operatore sanitario se l'aspiratore non funziona.
- Mantenere l'aspiratore Invia Liberty pulito e asciutto.
- Non immergere mai l'aspiratore Invia Liberty in acqua o altri liquidi.
- Se l'aspiratore Invia Liberty si bagna, strofinarlo con un panno asciutto.
- Non asciugare l'aspiratore Invia Liberty nel microonde.
- Tenere l'aspiratore Invia Liberty fuori dalla portata di bambini e animali domestici.
- È necessaria la supervisione quando l'aspiratore Invia Liberty viene utilizzato in prossimità di bambini.
- Tenere l'aspiratore Invia Liberty al riparo dalla luce solare diretta.
- Rischio di esplosione – l'aspiratore Invia Liberty non è destinato all'uso in ambienti potenzialmente esplosivi, tra cui ambienti arricchiti di ossigeno e in presenza di anestetici infiammabili.
- Le apparecchiature di comunicazione wireless, come dispositivi di rete domestica wireless, telefoni cellulari, cordless e relative stazioni base e ricetrasmittitori palmari, possono interferire con il funzionamento dell'aspiratore Invia Liberty e devono essere mantenute a una distanza di almeno 30 cm. Ciò può causare una

carica di batteria insufficiente o può portare a un guasto interno. Consultare il capitolo “Notifiche e risoluzione dei problemi” per le azioni da intraprendere in caso di guasto interno.

- Questo prodotto contiene batterie agli ioni di litio che possono causare incendi, esplosioni e ustioni. Le batterie non vanno smontate, rotte, riscaldate a una temperatura superiore a 100 °C, incenerite o gettate nel fuoco.

In caso di cambiamento nel livello di vuoto o di una condizione d'errore, spostare l'aspiratore Invia Liberty ad almeno 30 cm dal telefono cellulare quando si effettuano o ricevono chiamate.

Accendere e spegnere nuovamente l'aspiratore Invia Liberty per resettarlo dopo una condizione d'errore. Se possibile, si raccomanda una distanza di sicurezza minima di 30 cm tra l'aspiratore Invia Liberty e i telefoni cellulari.

Durante il sonno



- Accertarsi che il tubo dell'aspiratore Invia Liberty non si pieghi.
- Evitare che l'aspiratore Invia Liberty cada sul pavimento mentre si dorme.
- Caricare sempre l'aspiratore Invia Liberty quando si va a dormire.

Doccia, bagno e igiene personale



- Non utilizzare l'aspiratore Invia Liberty durante il bagno o la doccia.
- L'aspiratore Invia Liberty può essere scollegato dalla medicazione per un breve periodo di tempo (fino a 20 minuti) per cambiarsi i vestiti o per le operazioni di igiene personale. Consultare l'operatore sanitario per discutere un programma di igiene.
- Evitare che l'aspiratore Invia Liberty si bagni.
- Non collocare l'aspiratore Invia Liberty in un luogo da cui possa cadere, in una doccia, un lavandino o una vasca.
- Non toccare l'aspiratore Invia Liberty se è caduto nell'acqua. Scollegare immediatamente il dispositivo dalla presa elettrica e disconnettere l'aspiratore dalla medicazione.

Prima di uscire di casa



- Controllare il livello della batteria e se necessario ricaricarla prima di uscire di casa.
- Per praticità, inserire l'aspiratore Invia Liberty nella borsa per il trasporto.
- Non dimenticare di portare con sé un contenitore di ricambio e l'alimentatore.

Istruzioni per la configurazione



AVVERTENZA

Controllare frequentemente l'aspiratore Invia Liberty e la medicazione per assicurarsi che sia in funzione. Controllare visivamente la medicazione della ferita, l'area attorno alla ferita e il fluido nel contenitore per verificare la presenza di segni di infezione o altre complicazioni secondo le istruzioni del proprio medico.

Accensione

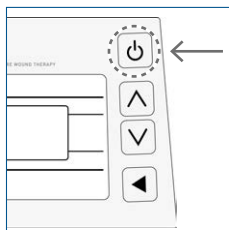

Accendere l'aspiratore Invia Liberty premendo [].

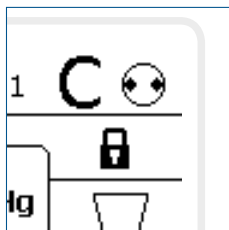

Schermata del display quando l'aspiratore è in funzione. L'indicatore di funzionamento/Standby sta ruotando [].



AVVERTENZA

Non tentare di effettuare la terapia senza la supervisione del medico.



AVVERTENZA

Il sistema NPWT deve funzionare 24 ore al giorno. Non interrompere la terapia salvo diverse istruzioni da parte del medico o in presenza di sanguinamento eccessivo.



AVVERTENZA

Se la terapia viene interrotta per più di 2 ore, la medicazione deve essere sostituita e la terapia deve essere riavviata dal medico.



AVVERTENZA

L'aspiratore Invia Liberty non rileva intasamenti lungo il tubo collegato all'adattatore di drenaggio o collegato al braccio curvo del connettore a Y. Durante il giorno, controllare frequentemente il tubo della medicazione collegato all'adattatore di drenaggio o al braccio curvo del connettore a Y per accertarsi che il tubo non sia piegato o bloccato.

In caso di intasamento lungo il tubo collegato all'adattatore di drenaggio o lungo il tubo collegato al braccio curvo del connettore a Y, contattare l'operatore sanitario.

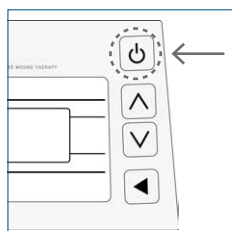

Spegnimento

Spegnere l'aspiratore Invia Liberty premendo [] per 3 secondi. Premere solo una volta.

Montaggio della borsa per il trasporto

L'aspiratore Invia Liberty è progettato per essere portato nella borsa per il trasporto durante il funzionamento.



- 1 Aprire la borsa per il trasporto.
- 2 Inserire l'aspiratore Invia Liberty nell'apposita tasca.
- 3 Chiudere il velcro sopra l'aspiratore.

La tracolla può essere utilizzata anche come cintura. A tal fine, slacciare la cinghia ai lati della borsa per il trasporto e infilarla nei due passanti, che si trovano nella parte posteriore della borsa per il trasporto.

Carica della batteria

Quando la batteria è completamente carica, la sua durata generalmente supera le 14 ore. Se l'aspiratore Invia Liberty funziona di continuo a causa di una perdita d'aria, potrebbe essere necessario ricaricare la batteria con più frequenza.

Simboli del livello della batteria



mezza piena / piena / esaurita completamente

Se la batteria si esaurisce completamente, seguire le istruzioni indicate di seguito.

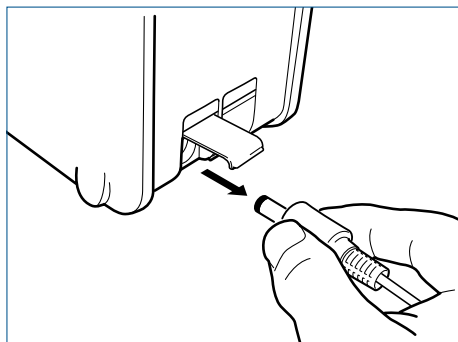

Aprire la porta dell'adattatore di rete Collegare l'aspiratore Invia Liberty alla presa elettrica mediante l'alimentatore fornito in dotazione con l'aspiratore. Collegare l'altra estremità dell'alimentatore a una presa a muro. Quando le barrette del simbolo della batteria si muovono la batteria è in carica.

La batteria è completamente carica dopo circa 4 ore. Quando la batteria è carica e continua ad essere collegata alla rete elettrica il simbolo  apparirà fisso sul display. Quando la carica è completa, scollegare l'alimentatore dal muro e disconnettere l'aspiratore Invia Liberty dall'alimentatore.

Chiudere la porta dell'adattatore di rete premendo il coperchio di protezione verso il basso.



ATTENZIONE

Continuare la terapia NPWT durante la carica della batteria dell'aspiratore. Non spegnere l'aspiratore durante la carica.

Caricare sempre la batteria quando si va a dormire.

Porta dell'adattatore
di rete





Cambiare il contenitore

Sostituire il contenitore almeno una volta a settimana o quando il contenitore è pieno o si attiva l'allarme, in base alle istruzioni che appaiono sul display dell'aspiratore.

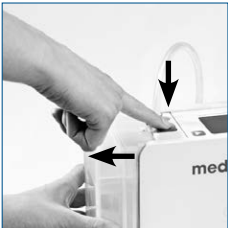
- 1 Lavarsi le mani.
- 2 Premere il pulsante "Standby" [ >3 secondi] e l'aspiratore si spegnerà.

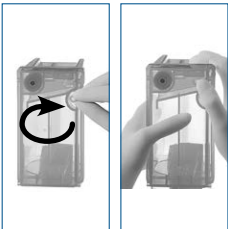
- 3  Premere il pulsante di rilascio nella parte superiore dell'aspiratore e rimuovere il contenitore.

- 4  Chiudere il contenitore usato con un tappo situato a lato del contenitore.

- 5  Togliere dall'imballo il nuovo contenitore e rimuovere l'adesivo di sicurezza, posizionando i piedini in fondo al contenitore nelle scanalature alla base dell'aspiratore. Premere il contenitore verso l'alto e inserirlo nell'aspiratore Invia Liberty fino a sentire clic.



ATTENZIONE

Non utilizzare il contenitore Invia Liberty se la confezione sterile è danneggiata.

6



Accendere l'aspiratore Invia Liberty premendo "Acceso" [▶] per riprendere la terapia e inserire l'aspiratore nella borsa per il trasporto.

7 Smaltire il contenitore usato secondo le istruzioni fornite dal proprio medico.

Collegare/scollegare il connettore rapido

Il connettore rapido può essere scollegato per un breve periodo di tempo (fino a 20 minuti) per cambiarsi i vestiti o per le operazioni di igiene personale. Durante questo tempo l'aspiratore può essere impostato in modalità "Standby" per un intervallo di 5 minuti, dopodiché si attiverà l'allarme della "modalità Standby", il quale potrà essere silenziato per altri 5 minuti.

- 1 Lavarsi le mani.
- 2 Chiudere il morsetto sul tubo del contenitore e chiudere il morsetto sul tubo della medicazione.
- 3 Premere il pulsante "Standby" [▶ >3 secondi] e l'aspiratore si spegnerà.



4

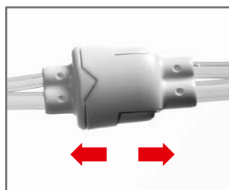
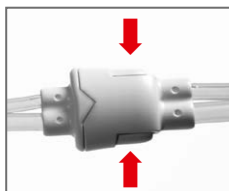

Scollegare il connettore rapido premendo sotto i lati del connettore.

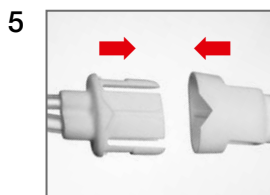

Per ricollegare il connettore rapido, premere le due estremità del connettore rapido l'una contro l'altra finché non scattano in posizione.

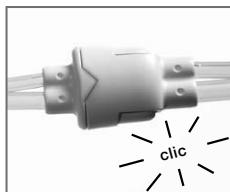

Aprire il morsetto sul tubo del contenitore e aprire il morsetto sul tubo della medicazione.

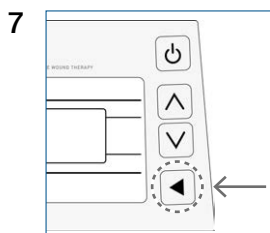

Premere “Acceso” [] per riprendere la terapia.

Notifiche e risoluzione di problemi



Non spaventarsi se si attiva il segnale acustico.
Seguire le istruzioni indicate di seguito.

- 1 Se l'aspiratore Invia Liberty si trova nella borsa per il trasporto, aprire il coperchio della borsa per il trasporto.
- 2 Premere [] per silenziare il segnale acustico per 60 secondi (può essere premuto ogni volta che si attiva il segnale).





Tabella Allarme

Avvertenza	401	<p>Batteria quasi esaurita</p> <p>401</p> <p>Muto Standby (3 sec.)</p>	<p>Caricare batteria</p> <p>Standby (3 sec.)</p>
	405	<p>Modalità Standby</p> <p>405</p> <p>Muto Acceso</p>	<p>Accendere o spegnere la pompa</p> <p>Acceso</p>
	406	<p>Temperatura interna elevata</p> <p>406</p> <p>Muto Standby (3 sec.)</p>	<p>Rimuovere la pompa dalla fonte di calore (ad es. luce solare diretta) o rimuovere eventuali coperture aggiuntive (ad es. coperta).</p> <p>Standby (3 sec.)</p>
Allarme	301	<p>Perdita nel sistema</p> <p>301</p> <p>Muto Standby (3 sec.)</p>	<p>Verificare il sistema per rilevare eventuali perdite. Verificare che il recipiente sia inserito correttamente.</p> <p>Consultare il foglietto illustrativo per ulteriori istruzioni.</p> <p>Standby (3 sec.)</p>
	302	<p>Sistema ostruito</p> <p>302</p> <p>Muto Standby (3 sec.)</p>	<p>Verificare che il tubo sia libero e non piegato. Verificare se il serbatoio è pieno.</p> <p>Per ulteriori informazioni, consultare le istruzioni per l'uso.</p> <p>Standby (3 sec.)</p>

	Annotazioni/possibile causa dell'errore
	<p>Ricaricare la batteria posizionando l'aspiratore Invia Liberty nella stazione di caricamento o inserire il caricabatterie sulla porta dell'adattatore di rete dell'aspiratore.</p> <p>Il tempo restante della batteria è di circa 30 minuti.</p>
	<p>Se l'aspiratore è in modalità Standby per più di 5 minuti, si attiva un allarme.</p> <p>Per continuare la terapia premere "Acceso" [].</p>
	<p>Raffreddare l'aspiratore Invia Liberty seguendo le istruzioni sul display.</p>
	<p>Medicazione:</p> <ul style="list-style-type: none"> - Controllare la medicazione per verificare la presenza di perdite d'aria. Premere con forza attorno alle estremità della medicazione, attorno al tubo di drenaggio o sull'Invia FitPad. - È possibile applicare un'ulteriore medicazione in film di poliuretano per sigillare l'area di perdita. <p>Raccordi:</p> <ul style="list-style-type: none"> - Accertarsi che il tubo della medicazione sia collegato correttamente al tubo del contenitore. - Accertarsi che il tubo del contenitore sia inserito dritto nell'aspiratore. <p>Contenitore:</p> <ul style="list-style-type: none"> - Accertarsi che il contenitore sia inserito correttamente, sganciare il contenitore e riposizionarlo. - Verificare la presenza della guarnizione arancione O-ring, collocata davanti al tubo del contenitore nell'aspiratore. Ulteriori guarnizioni O-ring sono disponibili mediante il rappresentante Medela.
	<p>Contattare l'operatore sanitario.</p>

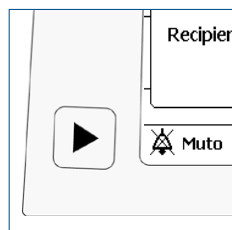

Allarme	305			
	306			
	311			
	313			
Errore interno				



ATTENZIONE

Se non si è in grado di identificare qualsiasi simbolo o di capire l'allarme sul display, contattare l'operatore sanitario.

Annotazioni/possibile causa dell'errore	
	<p>Ricaricare la batteria posizionando l'aspiratore Invia Liberty nella stazione di caricamento o inserire il caricabatterie sulla porta dell'adattatore di rete dell'aspiratore.</p> <p>Il tempo restante della batteria è di circa 15 minuti.</p>
	<p>Sostituire il contenitore; per maggiori dettagli, consultare il capitolo "Sostituire il contenitore".</p>
	<p>Contenitore: - Sganciare il contenitore e riposizionarlo. Tubi: - Accertarsi che il tubo non sia attorcigliato, piegato o clampato.</p>
	<p>Sostituire il contenitore. Per maggiori dettagli, consultare il capitolo "Sostituire il contenitore".</p>
	<p>Riavviare l'aspiratore. Se l'errore interno persiste, spegnere il dispositivo premendo [ >3 secondi] e contattare l'operatore sanitario.</p>



AVVERTENZA

Se l'aspiratore smette di funzionare o non può essere acceso, contattare immediatamente l'operatore sanitario.

Pulizia/Disinfezione



L'aspiratore Invia Liberty può essere pulito con un panno inumidito usando un detergente delicato.

Garanzia



Il periodo di garanzia è di 2 anni dalla data di consegna. Il produttore non si assume alcuna responsabilità per danni o danni conseguenti ad uso improprio non conforme alle disposizioni o da parte di persone non autorizzate.

Manutenzione/controllo di sicurezza



I servizi di assistenza tecnica devono essere effettuati esclusivamente da personale autorizzato. Il controllo di sicurezza si limita a un'ispezione visiva per verificare eventuali danni all'involucro e al caricabatterie e deve essere effettuato prima di ogni uso. Se non si utilizza l'aspiratore Invia Liberty per lunghi periodi, la batteria deve essere caricata circa una volta ogni 6 mesi per assicurare un funzionamento ottimale.

Smaltimento



Consultare l'operatore sanitario per lo smaltimento di medicazioni, contenitori e tubi usati.

Dati tecnici



Condizioni di conservazione degli accessori

Gli accessori devono rimanere nella confezione ed essere conservati a temperature comprese nell'intervallo tra $-20\text{ }^{\circ}\text{C}$ e $+50\text{ }^{\circ}\text{C}$.

Condizioni ambientali di funzionamento



L'aspiratore Invia Liberty e gli accessori devono essere messi in funzione a temperature comprese nell'intervallo tra $+5\text{ }^{\circ}\text{C}$ e $+40\text{ }^{\circ}\text{C}$. Non mettere in funzione i prodotti in caso di caldo o freddo estremi. Evitare l'umidità elevata (ammessa una percentuale del 15-93%).



ATTENZIONE

Non mettere in funzione l'aspiratore Invia Liberty ad un'altezza superiore a 3000 metri sul livello del mare.

Classe di protezione IP33

IP33

L'aspiratore Invia Liberty è protetto contro l'ingresso di solidi superiori a 2,5 mm e lo stillicidio dell'acqua.

Segni e simboli



Questo simbolo indica un messaggio di **ATTENZIONE** o di **AVVERTENZA** associato all'apparecchio.



Questo simbolo indica un apparecchio di classe II.



Non smaltire il dispositivo con i rifiuti urbani indifferenziati (solo per UE).



Questo simbolo indica la data di produzione (quattro cifre per l'anno e due cifre per il mese).



Questo simbolo indica il nome e l'indirizzo del produttore.



Questo simbolo indica che l'apparecchio è sterilizzato mediante ossido di etilene.



Questo simbolo indica che questo dispositivo è soggetto a prescrizione medica. **ATTENZIONE:** la legge federale degli Stati Uniti autorizza la vendita di questo prodotto esclusivamente su prescrizione medica (solo per USA).



Questo simbolo indica un componente applicato di tipo BF.



Questo simbolo indica il codice di catalogo assegnato dal produttore.



Questo simbolo indica il numero di serie del produttore.



Questo simbolo indica il codice di lotto del produttore.



Questo simbolo indica la protezione contro l'ingresso di oggetti estranei solidi e contro gli effetti nocivi dovuti all'ingresso di acqua.



Questo simbolo indica che l'apparecchio non deve essere usato dopo la fine del mese e dell'anno indicati.



Questo simbolo indica di seguire le istruzioni per l'uso.



Questo simbolo indica la conformità ai requisiti di sicurezza supplementari di USA e Canada per le apparecchiature elettromedicali.



Questo simbolo indica di non utilizzare l'apparecchio se la confezione è danneggiata.

pcs

Questo simbolo indica il numero di pezzi.



Questo simbolo indica la presa di corrente continua.



Questo simbolo indica che il prodotto contrassegnato o il suo materiale è oggetto di un processo di recupero o riciclo.



Questo simbolo indica i limiti di umidità per funzionamento e conservazione.



Questo simbolo indica i limiti di pressione atmosferica per funzionamento e conservazione.



Questo simbolo indica di mantenere il dispositivo asciutto.



Questo simbolo indica che il dispositivo non deve essere esposto alla luce solare.



Questo simbolo indica che il dispositivo è fragile e deve essere maneggiato con attenzione.



Questo simbolo indica
un dispositivo monouso.
Non riutilizzare il dispositivo.



Questo simbolo indica i limiti di
temperatura per funzionamento,
trasporto e conservazione.



Questo simbolo indica che
il dispositivo è conforme alla
Direttiva sui Dispositivi Medici
93/42/CEE.



Questo simbolo indica
la corretta posizione verticale
dell'imballo.

EMC (compatibilità elettromagnetica)

Invia Liberty è stato sottoposto a test di compatibilità elettromagnetica conformemente ai requisiti della normativa IEC 60601-1-2:2007 e IEC 60601-1-2:2014 4a Edizione secondo le clausole 7 e 8.9.



AVVERTENZA

Non usare l'aspiratore Invia Liberty in prossimità di altri apparecchi né sovrapporlo ad essi. Se tali condizioni d'uso sono necessarie, osservare attentamente l'aspiratore Invia Liberty per verificarne il normale funzionamento nella configurazione in cui sarà usato.



AVVERTENZA

Non utilizzare accessori diversi da quelli specificati o venduti dal produttore come parti di ricambio per i componenti interni; ciò potrebbe causare l'aumento delle emissioni o la riduzione dell'immunità dell'aspiratore Invia Liberty.



AVVERTENZA

EMC

Le apparecchiature chirurgiche ad alta frequenza, reti radio o apparecchiature simili possono influire sul funzionamento del dispositivo e non devono essere utilizzate in combinazione con l'aspiratore Invia Liberty.

Avuksi

Lue käyttöohje kokonaan, ennen kuin yrität käyttää laitetta.

Jos sinulla on kysyttävää Invia Liberty -alipainehaavahoitojärjestelmästä, ota yhteyttä terveydenhuoltopalvelujen tarjoajaan / lääkäriin soittamalla seuraavaan numeroon:

TERVEYDENHUOLTOPALVELUJEN TARJOAJA /
LÄÄKÄRI YHTEYSTIEDOT:

Säilytä nämä potilaskäyttöohjeet paikassa, josta ne ovat helposti saatavilla.

Sisällysluettelo

Varoitukset, huomautukset ja turvaohjeet	228
Yleiset varoitukset.....	228
Laitteen tarkoitus.....	230
Käyttötarkoitus	230
Koska laitetta käytetään (Käyttötarkoitukset).....	231
Koska laitetta ei saa käyttää (Vasta-aiheet).....	231
Laitteen kuvaus	232
Näyttö.....	233
Käyttöön vaikuttavat olosuhteet.....	233
Yleinen turvallisuus kotona	234
Nukkuminen	235
Suihkussa käyminen, kylpeminen ja peseytyminen	235
Kun poistut asunnosta	236
Kokoamisohjeet	236
Valmistele kantolaukku	238
Lataa akku	238
Vaihda säiliö	240
Liitä/irrota Quick-connector	241
Ilmoitukset ja vianmääritys	243
Hälytystaulukko	244
Puhdistus/desinfiointi	248
Takuu	248
Kunnossapito/turvallisuustarkastus	248
Hävittäminen	248
Tekniset tiedot	249
Merkit ja symbolit	250
Sähkömagneettinen yhteensopivuus (EMC)	253

Varoitukset, huomautukset ja turvaohjeet



VAROITUS

Ilmoittavat mahdollisesta vaaratilanteesta, joka voi johtaa kuolemaan tai vakavaan loukkaantumiseen, ellei sitä vältetä.



HUOMAUTUKSET

Ilmoittavat mahdollisesta vaaratilanteesta, joka voi johtaa lievään tai kohtuulliseen loukkaantumiseen, ellei sitä vältetä.

Yleiset varoitukset



VAROITUS

Tämän laitteen päivittäisestä käytöstä vastaavan henkilön (potilaan, hoitajan) on pystyttävä lukemaan ja ymmärtämään näissä käyttöohjeissa ja imulaitteen näytöllä annetut ja terveydenhuollon ammattilaisen antamat käyttöohjeet sekä noudattamaan niitä. Hänen on kuultava äänisignaalit ja pystyttävä reagoimaan niihin. Käytä Invia Liberty -alipainehaavahoitojärjestelmää vain sen henkilön hoitoon, jolle se on määrätty, ja vain sen aiottuun käyttötarkoitukseen.

Älä suorita hoitoa keskustelematta ensin terveydenhuoltohenkilöiden ja terveydenhuollon ammattilaisten valvomina käyttöohjeissa koulutettujen hoidon antajien kanssa. Tähän laitteeseen ei saa tehdä muutoksia.



VAROITUS

Tarkasta haavan sidos ja Invia Liberty -järjestelmä silmämääräisesti usein.

Jos näet suuria määriä verta sidoksessa, letkussa tai säiliössä:

- 1 Sammuta imulaite painamalla  3 sekunnin ajan.
- 2 Kohdista haavaan painetta.
- 3 Hakeudu välittömästi ensiapuun.

Jos sinun on vaikea hengittää, hakeudu välittömästi ensiapuun.





VAROITUS

Ota heti yhteyttä terveydenhuollon ammattilaiseen, jos sinulla on seuraavia oireita:

- Huomattava näön tai kuulon menetys
- Kipu, arkuus tai punaisuus haavan ympärillä
- Turvotus, kutina tai ihottuma haavan ympärillä
- Kuume
- Vahva haju haavasta
- Paksua vihreää vuotoa tai mikä tahansa epätavallinen muutos vuodon värissä
- Pahoinvointi, oksentelu tai ripuli
- Kipeä kurkku, jossa on turvotusta
- Huimaus tai sekavuus
- Allergiset reaktiot, kuten punaisuus, ihottuma, turvotus tai kova kutina



VAROITUS

Kun terveydenhuollon ammattilainen on tehnyt imulaitteen paineen ja tilan asetukset, paina ainoastaan katkaisinta [], valmiustilapainiketta [] tai mykistyspainiketta [].



VAROITUS

Imulaitetta pitää käyttää 24 tuntia vuorokaudessa. Älä pysäytä imulaitetta, ellei terveydenhuollon ammattilainen neuvo niin tekemään tai ellei haava vuoda voimakkaasti.

Jos imulaite pysäytetään yli kahdeksi tunniksi, sidos tulee vaihtaa. Ota yhteyttä terveydenhuollon ammattilaiseen ja pyydä sidoksen vaihtamista.



VAROITUS

Jos imulaite lakkaa toimimasta eikä sitä voi käynnistää, ota heti yhteyttä terveydenhuollon ammattilaiseen.

Laitteen tarkoitus

Terveydenhuoltopalvelujen tarjoajasi on määrännyt sinulle alipainehaavanhoitoa (NPWT).

Alipainehaavanhoidon on osoitettu edistävän useiden erilaisten haavojen paranemista. Alipaine kohdistetaan haavaan imulaitteen avulla. Imu eli alipaine auttaa poistamaan nesteen haavasta ja edistää sen sulkeutumista. Terveydenhuollon ammattilainen asettaa erityisen sidoksen haavalle ja letku yhdistää haavan imulaitteen säiliöön. Imulaite käynnistetään sitten määrätyllä paineella poistamaan nestettä haavasta. Neste kertyy säiliöön. Hoito on päällä 24 tuntia vuorokaudessa.

Käyttötarkoitus

Aiottu käyttäjä

Invia Liberty -alipainehaavanhoitojärjestelmä on tarkoitettu terveydenhoidon ammattilaisten ja riittävästi koulutettujen maallikkokäyttäjien käytettäväksi.

Terveydenhoidon ammattilaisten vastuulla on kouluttaa maallikkokäyttäjät potilaskäyttöohjeiden mukaisesti ja selittää heille kaikki asiaan liittyvät turvallisuustiedot.

Aiottu potilasryhmä

Invia Liberty -alipainehaavanhoitojärjestelmä on tarkoitettu käyttöön potilaiden hoidossa vain käyttötarkoituskuvauksen mukaisissa tiloissa. Laitetta ei ole tutkittu pediatriisilla potilailla.

Tarkoitettu ympäristö

Invia Liberty -alipainehaavanhoitojärjestelmä on tarkoitettu käyttöön sairaalassa, laitoshoidossa ja kotihoidossa.

Koska laitetta käytetään (Käyttötarkoitukset)

Invia Liberty-alipainehaavanhoitojärjestelmä (NPWT) on tarkoitettu potilaille, jotka hyötyisivät imulaitteesta (alipainehaavanhoidosta), koska se luo ympäristön, joka edistää haavan paranemista toissijaisen tai kolmannen (viivästyneen ensisijaisen) käyttötarkoituksen avulla valmistelemalla haavapohjaa sulkemiseen, vähentämällä turvotusta, edistämällä granulaatiokudoksen muodostusta ja läpivirtausta sekä poistamalla tulehduseritettä ja infektoitunutta materiaalia. Kun Invia Liberty -alipainehaavanhoitojärjestelmää käytetään tarcoissa kirurgisissa leikkauksissa, se on myös tarkoitettu sellaisen kirurgisen leikkauksen ympäristön hallintaan, joka jatkaa vuotamista, kun se on suljettu ompeleella tai nitomalla, ylläpitämällä suljettua ympäristöä ja poistamalla eritettä alipainehaavanhoidolla.

Invia Liberty -alipainehaavanhoitojärjestelmä sopii seuraaviin käyttötarkoituksiin:

- Akuutit tai subakuutit haavat
- Krooniset haavat
- Auenneet haavat
- Painehaavat
- Diabeettiset/neuropaattiset haavat
- Laskimoiden vajaatoiminnasta johtuvat haava
- Traumaattiset haavat
- Toisen asteen palovammat
- Palkeenkielet ja ihosiirteet
- Suljetut kirurgiset leikkaukset

Koska laitetta ei saa käyttää (Vasta-aiheet)

Invia Liberty -alipainehaavanhoitojärjestelmä on vasta-aiheinen seuraavissa tiloissa:

- Nekroottinen, rupeutunut kudosis
- Hoitamaton osteomyeliitti
- Ei-enteeriset ja tutkimattomat fistelit
- Pahanlaatuisuus haavassa
- Paljaana oleva verisuonisto
- Paljaina olevat hermot
- Verisuonten anastomoottinen sijainti pinnassa tai ohitukset
- Paljaina olevat elimet

Jos sinulla on huolenaiheita, keskustele terveydenhuollon ammattilaisen kanssa.

Laitteen kuvaus

Tarkista Invia Liberty -järjestelmän toimituspakkauksen täydellisyys ja yleinen kunto.



VAROITUS

Älä käytä muita kuin seuraavassa kuvattavia lisävarusteita.

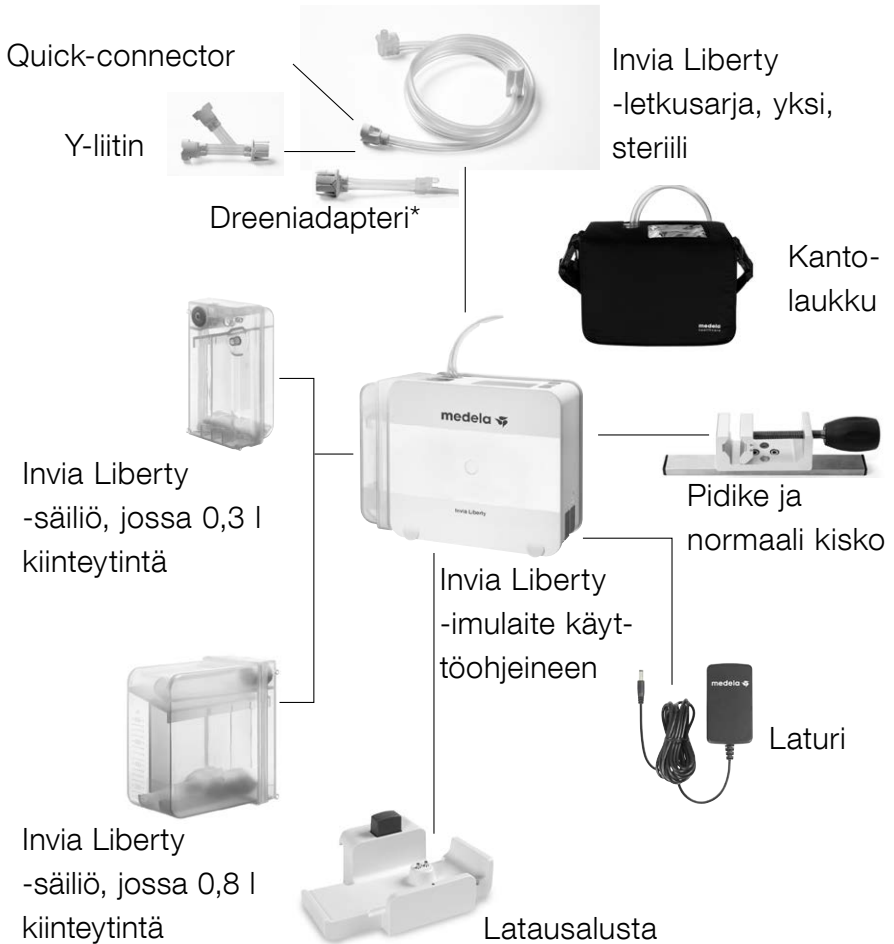

*Tuote ei ole saatavilla kaikissa maissa

Näyttö

Invia Liberty -imulaitteen käyttöpainikkeet

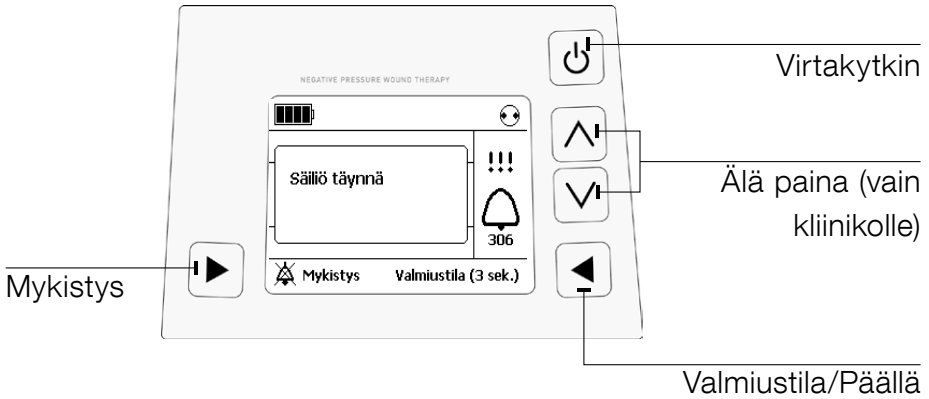

Käyttöön vaikuttavat olosuhteet



HUOMIO

Invia Liberty -imulaitteen on oltava käytön aikana pystysuorassa.



Yleinen turvallisuus kotona



Lue nämä varoitukset ja turvaohjeet ennen laitteen käyttöä ja noudata niitä. Nämä käyttöohjeet on säilytettävä laitteen yhteydessä. Huomaa, että nämä käyttöohjeet muodostavat yleisen oppaan tuotteen käyttöön. Lääketieteellisissä tilanteissa tulee kääntyä lääkärin puoleen.



HUOMAUTUKSET /VAROITUKSET

- Älä käytä jatkojohtoja Invia Liberty -imulaitteen kanssa.
- Sijoita virtajohto niin, että siihen ei voi kompastua.
- Älä koskaan laita virtajohtoa kaulasi ympärille.
- Pidä virtajohto erossa kuumista pinnoista.
- Älä koskaan irrota pistoketta pistorasiasta virtajohdosta vetämällä.
- Älä yritä mitenkään korjata Invia Liberty -imulaitetta. Jos imulaite ei toimi, ota yhteyttä terveydenhuollon ammattilaiseen.
- Pidä Invia Liberty -imulaite puhtaana ja kuivana.
- Älä koskaan upota Invia Liberty -imulaitetta veteen tai muihin nesteisiin.
- Jos Invia Liberty -imulaite kastuu, kuivaa se pyyhkeellä.
- Älä kuivaa Invia Liberty -imulaitetta mikroaaltouunissa.
- Pidä Invia Liberty -imulaite poissa lasten ja lemmikkien ulottuvilta.
- Valvonta on välttämätöntä, kun Invia Liberty -imulaitetta käytetään lasten läheisyydessä.
- Suojaa Invia Liberty -imulaite suoralta auringonvalolta.
- Räjähdyksivaara – Invia Liberty -imulaitetta ei ole tarkoitettu käytettäväksi räjähdysriskissä ympäristöissä, mukaan lukien happirikastetut ympäristöt ja alueet, joilla on syttyviä nukutusaineita.
- Langattomat viestintälaitteet, kuten langattomat kotiverkot, matkapuhelimet, langattomat puhelimet tukiasemineen ja radiopuhelimet, voivat vaikuttaa Invia Liberty -imulaitteeseen, ja ne on pidettävä vähintään 30 cm:n päässä siitä. Tämä voi

aiheuttaa riittämättömän akun latauksen tai johtaa sisäiseen virheeseen. Katso luvusta Ilmoitukset ja vianmääritys, mitä toimenpiteitä pitää suorittaa sisäisen virheen yhteydessä.

- Tämä tuote sisältää litium-ioniakkuja, joihin liittyy tulipalon, räjähdys- ja palovammojen riski. Älä pura, murskaa, lämmitä yli 100 °C:n lämpötilaan, polta tai hävitä tulella.

Jos havaitset muutoksen alipainetasossa tai virhetilan, siirrä Invia Liberty -imulaite vähintään 30 cm:n päähän matkapuhelimesta soit- taessasi tai vastaanottaessasi puheluita. Nollaa Invia Liberty -imu- laite virhetilan jälkeen kytkemällä se pois päältä ja takaisin päälle. Invia Liberty -imulaitteen ja matkapuhelimen välille suositellaan vähintään 30 cm:n turvaetäisyyttä aina, kun tämä on mahdollista.

Nukkuminen



- Varmista, että Invia Liberty -imulaitteen letkut eivät väännä.
- Estä Invia Liberty -imulaitteen putoaminen lattialle nukkuessasi.
- Lataa Invia Liberty -imulaite aina mennessäsi nukkumaan.

Suihkussa käyminen, kylpeminen ja peseytyminen



- Älä käytä Invia Liberty -imulaitetta kylvyssä tai suihkussa.
- Invia Liberty -imulaite voidaan irrottaa sidoksesta lyhyeksi aikaa (enintään 20 minuuttia) vaatteiden vaihtamista ja henkilökohtaista hygieniaa varten. Keskustele kylpysuunnitelmistasi terveydenhuollon ammattilaisen kanssa.
- Estä Invia Liberty -imulaitteen kastuminen.
- Älä laita Invia Liberty -imulaitetta paikkaan, missä se voi pudota suihkuun, pesualtaaseen tai ammeeseen.
- Älä koske Invia Liberty -imulaitteeseen, jos se on pudonnut veteen. Irrota pistoke välittömästi pistorasiasta ja imulaite sidoksesta.

Kun poistut asunnosta



- Tarkista akun tila ja lataa tarvittaessa ennen kotoa poistumista.
- Laita Invia Liberty -imulaite kantolaukkuun, jossa sitä on kätevä kuljettaa.
- Muista ottaa mukaan varasäiliö ja virtalähde.

Kokoamisohjeet



VAROITUS

Tarkasta Invia Liberty -imulaite ja sidos usein toimivuuden varmistamiseksi. Tarkista silmämääräisesti sidos, haavan ympäristö ja säiliössä oleva neste tulehdusten ja muiden sivuvaikutusten varalta terveydenhuollon ammattilaisen ohjeiden mukaisesti.

Käynnistä laite

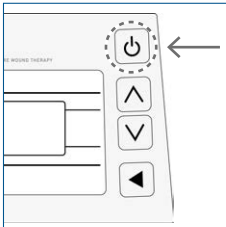

Käynnistä Invia Liberty -imulaite painamalla [].

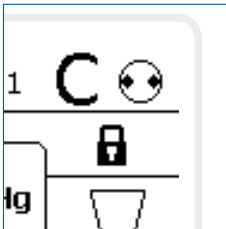

Näyttö imulaitteen ollessa käynnissä. Käyttö/valmiustila-ilmaisina pyörii [].



VAROITUS

Älä yritä suorittaa hoitoa ilman terveydenhuoltopalvelujen tarjoajan valvontaa.



VAROITUS

Alipainehaavahoitojärjestelmän pitää olla käynnissä 24 tuntia vuorokaudessa. Älä pysäytä imulaitetta, ellei terveydenhuollon ammattilainen neuvo niin tekemään tai ellei haava vuoda voimakkaasti.



VAROITUS

Jos hoito keskeytetään yli 2 tunniksi, terveydenhuollon ammattilaisen tulee vaihtaa sidos ja aloittaa hoito uudelleen.



VAROITUS

Invia Liberty -imulaite ei havaitse tukosta dreeniadapteriin tai Y-liittimen kaarevaan varteen kytketyssä letkussa. Tarkista dreeniadapteriin tai Y-liittimen kaarevaan varteen kytketty sidoksen letku usein päivän aikana varmistaaksesi, ettei se ole mutkalla tai tukossa.

Jos dreeniadapteriin tai Y-liittimen kaarevaan varteen kytketyssä letkussa havaitaan tukos, ota yhteyttä terveydenhuollon ammattilaiseen.

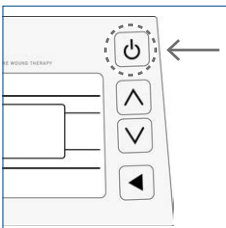

Sammuta laite

Sammuta Invia Liberty -imulaite pitämällä [] painettuna 3 sekuntia. Paina vain kerran.

Valmistele kantolaukku

Invia Liberty -imulaite on tarkoitettu pidettäväksi kantolaukussa käytön aikana.



- 1 Avaa kantolaukku.
- 2 Työnnä Invia Liberty -imulaite sitä varten tarkoitettuun taskuun.
- 3 Sulje tarra imulaitteen päälle.

Olkahihnaa voidaan käyttää myös vyöhihnana.

Voit tehdä niin irrottamalla hihnan kantolaukun sivuilta ja vetämällä sen kantolaukun takana olevien kahden lenkin läpi.

Lataa akku

Kun akku on ladattu täyteen, se riittää yleensä yli 14 tunnin käyttöön. Jos Invia Liberty -imulaite käy jatkuvasti ilmavuodon takia, akku pitää ehkä ladata aiemmin.

Akun tilasymbolit



täynnä puolillaan tyhjä

Jos akku tyhjenee kokonaan, noudata seuraavia ohjeita.

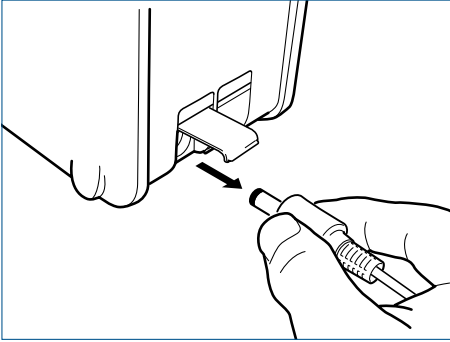

Avaa sähköliitännän suojuus. Kytke Invia Liberty -imulaite sen mukana toimitetun laturin sähköliittimeen. Kytke laturin toinen pää verkkovirtaan. Akkunäytön liikkuvat palkit ilmaisevat, että lataaminen on käynnissä.

Akku on ladattu täyteen noin 4 tunnin kuluttua. Jos akku on täyteen ladattu ja on edelleen kytketty virtalähteeseen,  näkyy jatkuvasti näytössä. Kun lataus on valmis, irrota laturi verkkovirrasta ja irrota Invia Liberty -imulaite laturista.

Sulje sähköliitäntä painamalla suojuus alas.



HUOMIO

Alipainehaavanhoitoa pitää jatkaa latauksen aikana.
Älä sammuta imulaitetta latauksen ajaksi.

Lataa akkua aina yöllä.

Sähköliitäntä



Vaihda säiliö

Vaihda säiliö imulaitteen näytöllä olevien ohjeiden mukaisesti vähintään kerran viikossa tai kun säiliö näyttää täydeltä tai äänihälytys kuuluu.

1 Pese kädet.

2 Paina "Valmiustila"-painiketta [ > 3 sekuntia], jolloin imulaitteen moottori pysähtyy.

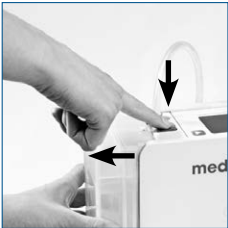
3  Paina vapautuspainiketta imulaitteen päällä ja poista säiliö.

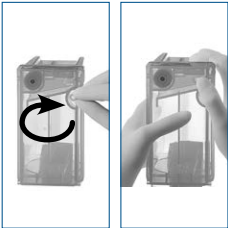
4  Sulje käytetty säiliö tiiviisti säiliön sivulla olevalla korkilla.

5  Pura uusi säiliö pakkauksesta ja poista turvatarra. Sijoita säiliön pohjassa olevat jalat imulaitteen kannassa oleviin uriin. Työnnä säiliötä ylös ja napsauta se Invia Liberty -imulaitteeseen.



HUOMIO

Älä käytä Invia Liberty -säiliötä, jos steriili pakkaus on vaurioitunut.

6



Käynnistä Invia Liberty -imulaite hoidon jatkamiseksi painamalla [] sekä työnnä imulaite kantolaukkuun.

7 Hävitä käytetty säiliö terveydenhuollon ammattilaisen ohjeiden mukaisesti.

Liitä/irrota Quick-connector

Quick-connector voidaan irrottaa lyhyeksi aikaa (enintään 20 minuuttia) vaatteiden vaihtamista ja henkilökohtaista hygieniaa varten. Tänä aikana imulaite voidaan asettaa valmiustilaan 5 minuutiksi, minkä jälkeen valmiustilan hälytys laukeaa ja sen voi mykistää toisen 5 minuutin jakson ajaksi.

1 Pese kädet.

2 Sulje puristin säiliön letkun ja sidoksen letkun ympärille.



3 Paina "Valmiustila"-painiketta [ > 3 sekuntia], jolloin imulaitteen moottori pysähtyy.

4

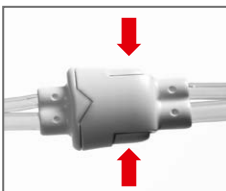

Irrota Quick-connector painamalla liittimen sivujen alta.

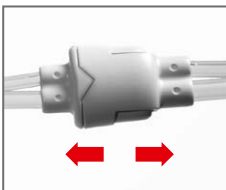

5

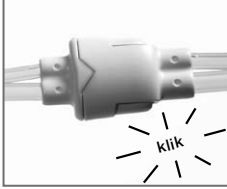
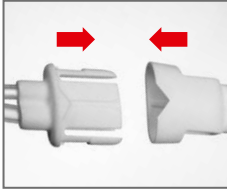

Voit kytkeä Quick-connectorin uudelleen puristamalla sitä yhteen, kunnes kuulet napsahduksen.

6



Avaa puristin säiliön letkun ja sidoksen letkun ympäriltä.

7

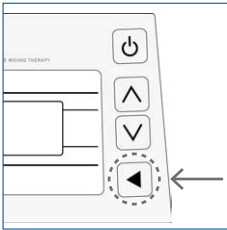

Jatka hoitoa painamalla [].

Ilmoitukset ja vianmääritys



Älä hätäännä, jos kuulet äänisignaalin.
Toimi seuraavien ohjeiden mukaan.

- 1 Jos Invia Liberty -imulaite on kantolaukussa, avaa kantolaukun kansi.
- 2 Mykistä äänisignaali 60 sekunniksi painamalla [] (voidaan painaa joka kerta, kun äänimerkki kuuluu).

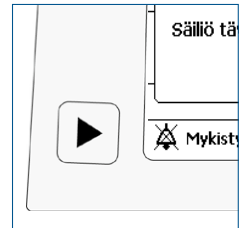

Hälytystaulukko

Varoitus	401	<p>Akku loppumassa</p> <p>Mykistys Valmiustila (3 sek.)</p>	<p>Lataa akku</p> <p>Valmiustila (3 sek.)</p>
	405	<p>Valmiustila</p> <p>Mykistys Päällä</p>	<p>Käynnistä tai sammuta pumppu</p> <p>Päällä</p>
	406	<p>Korkea sisälämpötila</p> <p>Mykistys Valmiustila (3 sek.)</p>	<p>Vie pumppu erilleen lämmönlähteestä (esim. suora auringonpaiste) tai poista mahdollinen lisäpeite (esim. huopa).</p> <p>Valmiustila (3 sek.)</p>
Hälytys	301	<p>Järjestelmässä on vuoto</p> <p>Mykistys Valmiustila (3 sek.)</p>	<p>Tarkista järjestelmä vuotojen varalta ja että säiliö on kunnolla paikallaan. Lisätietoa löytyy käyttöohjeesta.</p> <p>Valmiustila (3 sek.)</p>
	302	<p>Järjestelmä tukossa</p> <p>Mykistys Valmiustila (3 sek.)</p>	<p>Tarkista, että letkusto on puhdas eikä se ole kiertteellä. Tarkista, että säiliö on täynnä. Katso lisätiedot käyttöohjeesta.</p> <p>Valmiustila (3 sek.)</p>

Huomautuksia / vian mahdollinen syy	
	<p>Lataa akku joko laittamalla Invia Liberty -imulaite latausalustaan tai kytkemällä laturi imulaitteen sähköliitintään.</p> <p>Akun käyttöaikaa jäljellä noin 30 minuuttia.</p>
	<p>Jos imulaite on valmiustilassa yli 5 minuuttia, laukeaa hälytys.</p> <p>Jatka hoitoa painamalla [].</p>
	<p>Jäähdytä Invia Liberty -imulaite näytön ohjeiden mukaisesti.</p>
	<p>Sidos:</p> <ul style="list-style-type: none"> – Tarkasta sidos ilmavuodon varalta. Paina lujasti sidoksen reunojen ympäriltä, poistoletkun ympäriltä tai Invia FitPadia. – Voit sulkea vuotavan alueen tiiviisti lisäämällä kalvosidettä. <p>Liittimet:</p> <ul style="list-style-type: none"> – Varmista, että sidoksen letku on kytketty oikein säiliön letkuun. – Varmista, että säiliön letku on työnnetty suoraan imulaitteeseen. <p>Säiliö:</p> <ul style="list-style-type: none"> – Varmista, että säiliö on asetettu oikein. Irrota säiliö ja aseta se uudelleen. – Varmista, että oranssi O-rengas/tiiviste, joka on asetettu säiliön letkun viereen imulaitteessa, on paikallaan. Uuden O-renkaan voi tilata Medela edustajalta.
	<p>Ota yhteyttä terveydenhuollon ammattilaiseen.</p>

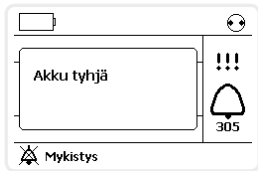
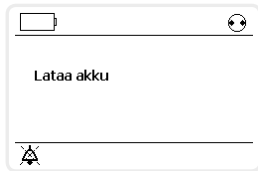
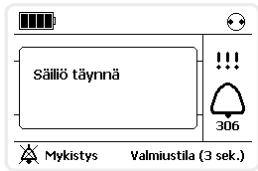
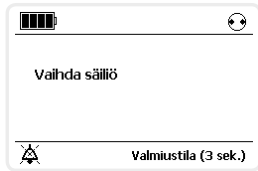
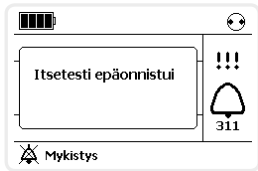
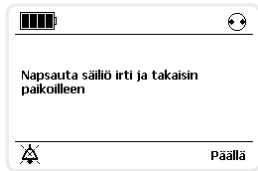
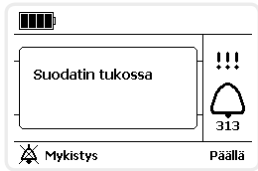
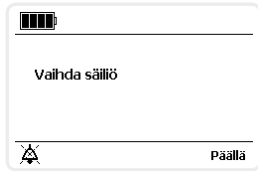
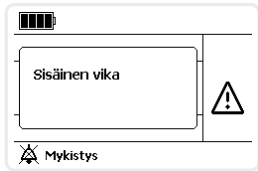
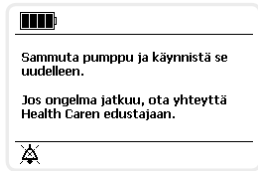
Hälytys	305			
	306			
	311			
	313			
Sisäinen virhe				



HUOMIO

Jos et tunnista jotakin merkkiä tai et ymmärrä näytöllä olevaa hälytystä, ota yhteyttä terveydenhuollon ammattilaiseen.

Huomautuksia / vian mahdollinen syy	
	<p>Lataa akku joko laittamalla Invia Liberty -imulaite latausalustaan tai kytkemällä laturi imulaitteen sähköliitintään.</p> <p>Akun käyttöaikaa jäljellä noin 15 minuuttia.</p>
	<p>Vaihda säiliö. Katso ohjeet luvusta Säiliön vaihtaminen.</p>
	<p>Säiliö: - Irrota säiliö ja aseta uudelleen. Letkusto: - Varmista, että letku ei ole vääntynyt, taittunut tai puristuksissa.</p>
	<p>Vaihda säiliö. Katso ohjeet luvusta Säiliön vaihtaminen.</p>
	<p>Käynnistä imulaite uudelleen. Jos sisäisen vian hälytys ei poistu, sammuta painamalla [ > 3 sekuntia] ja ota yhteyttä terveydenhuollon ammattilaiseen.</p>



VAROITUS

Jos imulaite lakkaa toimimasta eikä sitä voi käynnistää, ota heti yhteyttä terveydenhuollon ammattilaiseen.

Puhdistus/desinfiointi



Invia Liberty -imulaite voidaan pyyhkiä kostealla liinalla käyttämällä mietoa kotitalouden puhdistusainetta.

Takuu



Takuuaika on 2 vuotta toimitusajankohdasta lukien. Medela ei vastaa vahingoista tai välillisistä vahingoista, jotka ovat aiheutuneet epäasianmukaisesta käsittelystä, ohjeiden vastaisesta käytöstä tai mikäli laitetta ovat käyttäneet muut kuin valtuutetut henkilöt.

Kunnossapito/turvallisuustarkastus



Vain pätevä ja valtuutettu henkilökunta saa tehdä huoltotöitä. Turvallisuustarkastus rajoittuu kotelon ja laturin mahdollisten vaurioiden silmämääräiseen tarkistukseen, ja se pitää suorittaa ennen jokaista käyttöä. Jos Invia Liberty -imulaitetta ei käytetä, akku pitää ladata noin kerran 6 kuukaudessa optimaalisen toimintatehon varmistamiseksi.

Hävittäminen



Pyydä terveydenhuollon ammattilaiselta ohjeet käytettyjen sidosten, säiliöiden ja letkujen hävittämiseen.

Tekniset tiedot



Lisävarusteiden säilytysolosuhteet

Lisävarusteet on säilytettävä pakkauksissaan -20...+50 °C:n lämpötilassa.



Käyttöolosuhteet

Invia Liberty -imulaitteen ja sen lisävarusteiden käytön tulee tapahtua +5...+40 °C:n lämpötilassa. Älä käytä tuotteita erittäin kylmässä tai kuumassa lämpötilassa. Vältä suurta suhteellista kosteutta (sallittu kosteusalue on 15–93 %).



HUOMIO

Älä käytä Invia Liberty -imulaitetta yli 3 000 metrin korkeudella merenpinnan yläpuolella.

Suojausluokka IP33

IP33

Invia Liberty -imulaite on suojattu yli 2,5 millimetrin kokoisten kiinteiden hiukkasten ja vesipisaroiden tunkeutumista vastaan.

Merkit ja symbolit



Tämä merkki viittaa laitetta koskevaan HUOMAUTUKSEEN tai VAROITUKSEEN.



Tämä symboli viittaa luokan II laitteeseen.



Laitetta ei pidä hävittää jätteillemattoman kotitalousjätteen mukana (vain EU).



Tämä symboli ilmoittaa valmistusajankohdan (vuosi neljällä ja kuukausi kahdella numerolla).



Tämä merkki osoittaa valmistajan nimen ja osoitteen.



Tämä merkki kertoo, että laite on steriloitu eteenioksidilla.



Tämä merkki viittaa lääkärin määräyksestä käytettävään laitteeseen. HUOMIO: Yhdysvaltain liittovaltion lain mukaan tätä laitetta saa myydä vain lääkäri tai lääkärin määräyksestä (koskee vain Yhdysvaltoja).



Tämä symboli tarkoittaa BF-tyyppistä osaa.



Tämä merkki osoittaa laitteen valmistajan luettelonumeron.



Tämä symboli viittaa valmistajan sarjanumeroon.



Tämä symboli viittaa valmistajan eräkoodiin.



Tämä symboli viittaa suojaukseen kiinteiden vieraiden esineiden ja veden sisäänpääsyn haittavaikutuksilta.



Tämä merkki tarkoittaa, että laitetta ei tule käyttää tässä näkyvän vuoden ja kuukauden päätyttyä.



Tämä merkki osoittaa, että käyttöohjeita on noudatettava.



Tämä merkki osoittaa yhdenmukaisuuden lääkinnällisiä laitteita koskevien Yhdysvaltain ja Kanadan muiden turvallisuusvaatimusten kanssa.



Tämä symboli tarkoittaa, että laitetta ei saa käyttää, jos pakkaus on vaurioitunut.

pcs

Tämä merkki ilmaisee tuotteiden lukumäärän.



Tämä symboli tarkoittaa tasavirtaa.



Tämä merkki osoittaa, että merkitty osa tai sen materiaali on osa kierrätyskäsitelyä.



Tämä merkki osoittaa, että käyttöön ja säilytykseen liittyy kosteusrajoitus.



Tämä merkki osoittaa, että käyttöön ja säilytykseen liittyy ilmanpainerajoitus.



Tämä merkki osoittaa, että laite on pidettävä kuivana.



Tämä merkki osoittaa, että laite on pidettävä poissa auringonvalosta.



Tämä merkki osoittaa, että laitetta on käsiteltävä varovasti.



Tämä merkki tarkoittaa kertakäyttölaitetta. Älä käytä laitetta uudelleen.



Tämä merkki osoittaa, että käyttöön, kuljetukseen ja säilytykseen liittyy lämpötilarajoitus.



Tämä symboli tarkoittaa lääkinnällisistä laitteista annetun direktiivin 93/42/ETY vaatimustenmukaisuutta.



Tämä merkki osoittaa kuljetuspakkauksen oikean pystysuoran asennon.

Sähkömagneettinen yhteensopivuus (EMC)

Invia Liberty on EMC-testattu ja täyttää standardien IEC 60601-1-2:2007 ja IEC 60601-1-2:2014, 4. versio, vaatimukset kohtien 7 ja 8.9 mukaisesti.



VAROITUS

Invia Liberty -imulaitetta ei saa käyttää muiden laitteiden vieressä tai päällä. Jos laitteiden käyttö vierekkäin tai päällekkäin on välttämätöntä, Invia Liberty -imulaitetta tulee tarkkailla sen varmistamiseksi, että se toimii normaalisti aiotussa kokoonpanossa.



VAROITUS

Älä käytä muita lisävarusteita kuin valmistajan määrittämiä tai myymiä sisäisten komponenttien varaosia, sillä se saattaa lisätä Invia Liberty -imulaitteen päästöjä tai heikentää sen häiriöidensietoa.



VAROITUS

EMC

Kirurgiset korkeataajuuslaitteet, radioverkot tai vastaavat voivat vaikuttaa laitteen toimintaan, eikä niitä saa käyttää Invia Liberty -imulaitteen yhteydessä.

Assistance

Læs hele brugsanvisningen, før du prøver at betjene produktet.

Hvis du har spørgsmål til dit Invia Liberty-system til sårbehandling med negativt tryk, bedes du kontakte din læge/sygeplejerske på nedenstående telefonnummer:

LÆGE/SYGEPLEJERSKE
KONTAKTOPLYSNINGER:

Opbevar denne brugsanvisning til patienter på et let tilgængeligt sted.

Indholdsfortegnelse

Advarsler, forsigtighedsregler og sikkerhedsanvisninger	256
Generelle advarsler	256
Apparatets formål	258
Tilsluttet anvendelse	258
Årsager til at anvende apparatet (indikationer)	259
Årsager til ikke at anvende apparatet (kontraindikationer)	259
Beskrivelse af produktet	260
Display	261
Forhold, der har indflydelse på brugen	261
Generel sikkerhed i hjemmet	262
Søvn	263
Brusebad, bad og vask	263
Når du forlader huset	264
Opsætningsanvisninger	264
Opsætning af bæretasken	266
Opladning af batteri	266
Udskift beholderen	268
Tilslut/frakobl quick-samlingen	269
Meddelelser og fejlfinding	271
Alarmoversigt	272
Rengøring/desinfektion	276
Garanti	276
Vedligeholdelse/sikkerhedsrelaterede eftersyn	276
Bortskaffelse	276
Tekniske specifikationer	277
Tegn og symboler	278
Elektromagnetisk kompatibilitet (EMC)	281

Advarsler, forsigtighedsregler og sikkerhedsanvisninger

ADVARSEL

Markerer en potentielt faretruende situation, der ved manglende overholdelse af sikkerhedsanvisningerne kan medføre død eller alvorlige skader.

FORSIGTIGHEDSREGLER

Indikerer en potentielt faretruende situation, hvis sikkerhedsanvisningerne ikke overholdes, kan det medføre mindre eller moderate skader.

Generelle advarsler

ADVARSEL

Den person, som er ansvarlig for den daglige betjening af dette produkt (patient, plejemedarbejder), skal kunne læse, forstå og følge anvisningerne i denne brugsanvisning, på pumpens display og fra lægen. Personen skal kunne høre og reagere på lydsignaler. Invia Liberty NPWT-systemet må kun anvendes til den person, den er bestilt til, og kun til den tilsigtede brug.

Behandlingen må ikke udføres uden forudgående kontakt med sundhedspersonale og plejemedarbejdere, der er trænet i brugsanvisningen, og lægens tilsyn.

Det er ikke tilladt at ændre dette udstyr.

ADVARSEL

Efterse sårbandagen og Invia Liberty-systemet hyppigt. Hvis du ser store mængder blod i bandagen, slangen eller beholderen:

- 1 Sluk for pumpen ved at trykke på  og holde knappen inde i 3 sekunder.
- 2 Læg tryk på såret.
- 3 Søg omgående akut lægehjælp.

Hvis du får vejrtrækningsbesvær, skal du søge omgående akut lægehjælp.





ADVARSEL

Kontakt omgående din læge, hvis du oplever følgende symptomer:

- Betydeligt syns- eller høretab
- Smerte, ømhed eller rødme omkring såret
- Hævelse, kløe eller udslæt omkring såret
- Feber
- Stærk lugt fra såret
- Tyk, grøn drænvæske eller enhver usædvanlig farve på drænvæsken
- Kvalme, opkastning eller diarré
- Ondt i halsen med hævelse
- Svimmelhed eller forvirring
- Allergiske reaktioner som rødme, udslæt eller nældefeber, hævelse eller stærk kløe



ADVARSEL

Når lægen har indstillet pumpetrykket og funktionsindstillingerne, må du ikke trykke på andre knapper end tænd/sluk-knappen [], standby-knappen [] eller knappen for lydløs [].



ADVARSEL

Pumpen skal anvendes 24 timer i døgnet. Du må ikke standse pumpen, medmindre din læge siger, at du skal, eller hvis der opstår kraftig blødning.

Hvis pumpen stoppes i mere end 2 timer, skal bandagen skiftes. Kontakt din læge for at bede om et bandageskift.



ADVARSEL

Hvis pumpen holder op med at virke eller ikke kan tændes, skal du straks ringe til din læge.

Apparatets formål

Din læge har ordineret sårbehandling med negativt tryk (NPWT) til dig.

Sårbehandling med negativt tryk har vist sig at bidrage til at fremme heling af forskellige typer sår. Negativt tryk (sug) tilføres til såret gennem en pumpe. Suget eller det negative tryk er med til at fjerne væske fra såret og lukke det. Din læge vil anbringe en særlig bandage på dit sår, og der vil være en slange, der går fra dit sår til beholderen på pumpen. Derefter tændes pumpen på det ordinerede tryk for at fjerne væske fra dit sår. Væsken løber ind i beholderen. Behandlingen vil foregå 24 timer i døgnet.

Tilsigtet anvendelse

Brugermålgruppe

Invia Liberty NPWT-systemet er beregnet til at blive anvendt af uddannet sundhedspersonale eller af tilstrækkeligt trænedede ikke-uddannede brugere.

Sundhedspersonalet er ansvarlig for at træne ikke-uddannede brugere i henhold til patientbrugsanvisningen og forklare alle de relaterede sikkerhedsoplysninger.

Patientmålgruppe

Invia Liberty NPWT-systemet er kun beregnet til at blive anvendt på patienter, der udviser lidelser som dem, der er beskrevet i indikationerne. Produktet er ikke undersøgt hos pædiatriske patienter.

Tilsigtet miljø

Invia Liberty NPWT-systemet er beregnet til akut og langvarig hospitalsanvendelse samt til anvendelse i hjemmet.

Årsager til at anvende apparatet (indikationer)

Invia Liberty-systemet til sårbehandling med negativt tryk (NPWT) er indiceret til patienter, der kan have gavn af en sugeanordning (NPWT), da det skaber et miljø, der fremmer sekundær eller tertiær (forsinket primær) sårheling ved at forberede sårbunden til lukning, reducere ødem, fremme dannelsen af granulationsvæv og perfusion og ved at fjerne ekssudat og infektiøst materiale. Når det anvendes på lukkede kirurgiske incisioner er Invia Liberty NPWT-systemet også beregnet til behandling af miljøet omkring kirurgiske incisioner, der fortsat væsker efter lukning med suturer eller staples, ved at opretholde et lukket miljø og fjerne ekssudat via anvendelse af sårbehandling med negativt tryk.

Invia Liberty NPWT-systemet egner sig til følgende indikationer:

- Akutte eller subakutte sår
- Kroniske sår
- Rumperede sår
- Tryksår
- Diabetiske/neuropatiske sår
- Sår som følge af venøs insufficiens
- Traumatiske sår
- Delhudsforbrændinger
- Lapper og grafter
- Lukkede kirurgiske incisioner

Årsager til ikke at anvende apparatet (kontraindikationer)

Invia Liberty NPWT system er kontraindiceret, hvis der foreligger:

- Nekrotisk væv med skorpedannelse
- Ubehandlet osteomyelitis
- Ikke-enteriske og ueksplorerede fistler
- Malignitet i såret
- Blotlagte blodkar
- Blotlagte nerver
- Blotlagt anastomosested for blodkar eller bypass
- Blotlagte organer

Hvis du har betænkeligheder, skal du tale med din læge.

Beskrivelse af produktet

Kontrollér ved levering, at indholdet af pakken med Invia Liberty-systemet er komplet og generelt i god stand.



ADVARSEL

Anvend ikke andet tilbehør end det, der er beskrevet herunder.

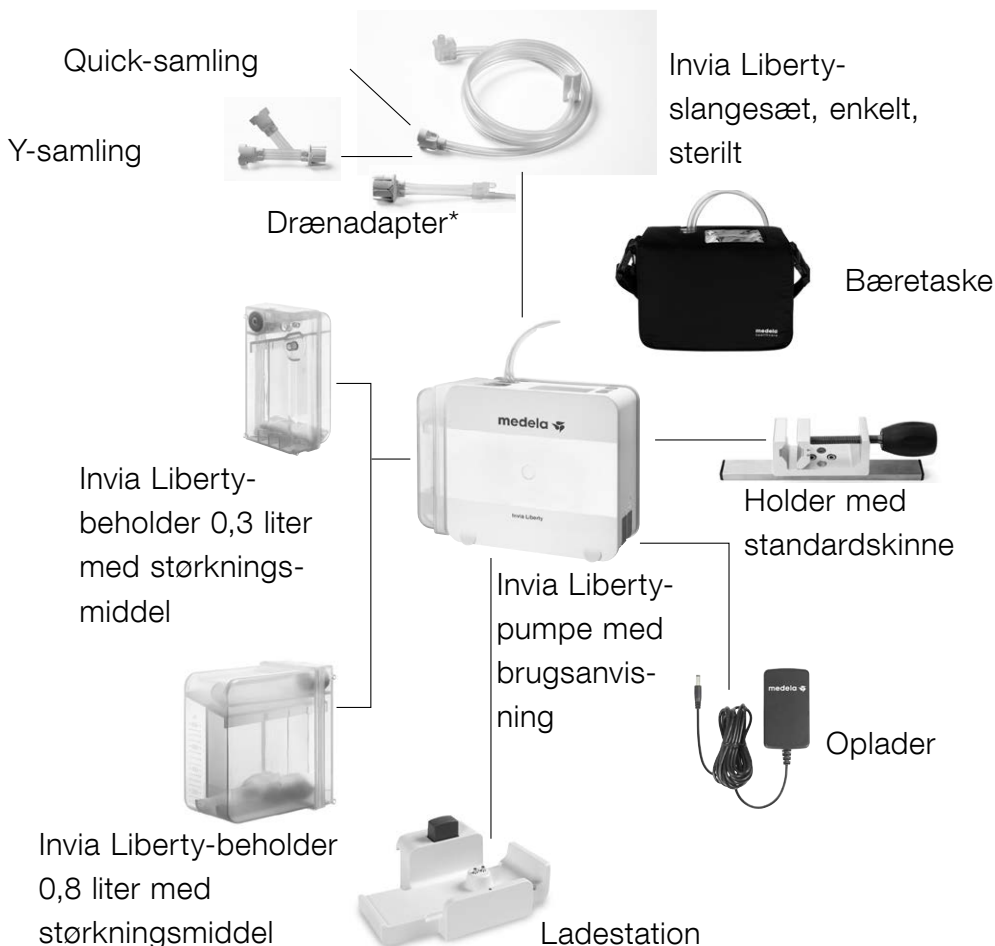

*Produktet fås ikke i alle lande

Display

Betjeningsknapper på Invia Liberty-pumpen

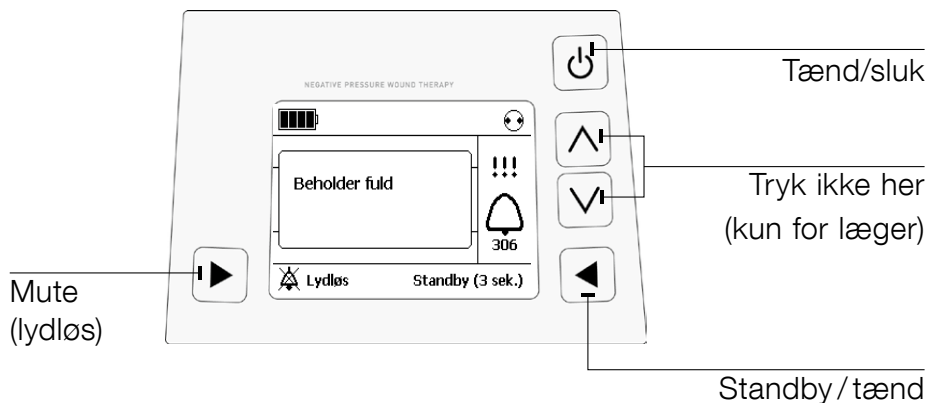

Forhold, der har indflydelse på brugen



FORSIGTIG

Invia Liberty-pumpen skal stå oprejst under brug.

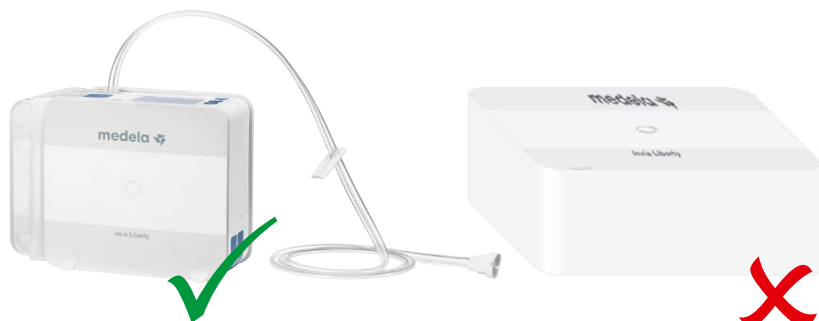

Generel sikkerhed i hjemmet



Læs og følg disse advarsler og sikkerhedsinstruktioner, inden apparatet betjenes. Denne brugsanvisning skal opbevares sammen med apparatet. Bemærk, at denne brugsanvisning er en general vejledning i anvendelse af produktet. Medicinske situationer skal håndteres af en læge.

FORSIGTIGHEDSREGLER/ADVARSLER

- Brug ikke forlængerledninger sammen med Invia Liberty-pumpen.
- Anbring strømkablet, så man ikke kan snuble eller falde over det.
- Læg aldrig strømforsyningsledningen omkring halsen.
- Hold strømledningen på afstand af varme overflader.
- Træk aldrig stikket ud af stikkontakten ved at trække i ledningen.
- Forsøg ikke at reparere Invia Liberty-pumpen. Kontakt din læge eller sygeplejerske, hvis pumpen ikke virker.
- Hold Invia Liberty-pumpen ren og tør.
- Invia Liberty-pumpen må aldrig placeres i vand eller væske.
- Tør Invia Liberty-pumpen med et håndklæde, hvis den bliver våd.
- Invia Liberty må ikke tørres i en mikrobølgeovn.
- Opbevar Invia Liberty-pumpen utilgængeligt for børn og kæledyr.
- Overvågning er nødvendig, når Invia Liberty-pumpen anvendes i nærheden af børn.
- Beskyt Invia Liberty-pumpen mod direkte sollys.
- Eksplosionsfare – Invia Liberty-pumpen må ikke anvendes i potentielt eksplosionsfarlige miljøer, herunder oxygenberigede miljøer og i områder med brandfarlige anæstetika.
- Trådløst kommunikationsudstyr såsom udstyr til trådløst netværk i hjemmet, mobiltelefoner, trådløse telefoner og deres ladestationer samt walkie-talkier kan forstyrre Invia Liberty-pumpens drift og skal holdes mindst 30 cm fra Invia Liberty-pumpen. Det kan forårsage utilstrækkelig opladning af batteriet eller kan medføre en intern fejl. Se kapitlet Meddelelser og fejlfinding for at få oplysninger om, hvad man skal gøre i tilfælde af en intern fejl.

- Dette produkt indeholder lithium-ion-batterier, hvilket indebærer risiko for brand, eksplosion og forbrændinger. Må ikke skilles ad, knuses, opvarmes til over 100 °C, brændes eller bortskaffes ved forbrænding.

Hvis du bemærker en ændring i vakuumniveau eller en fejltilstand, skal du flytte Invia Liberty-pumpen mindst 30 cm væk fra mobiltelefonen, når du ringer op eller besvarer opkald. Tænd og sluk for Invia Liberty-pumpen igen for at nulstille den efter en fejltilstand. Når det er muligt, anbefales det at have en sikkerhedsafstand på 30 cm mellem Invia Liberty-pumpen og en mobiltelefon.

Søvn



- Sørg for, at der ikke kommer knæk på Invia Liberty-pumpens slange.
- Forebyg, at Invia Liberty-pumpen falder på gulvet, mens du sover.
- Oplad altid Invia Liberty-pumpen, når du går i seng.

Brusebad, bad og vask



- Invia Liberty-pumpen må ikke anvendes, når du går i bad eller brusebad.
- Invia Liberty-pumpen kan kobles fra bandagen i korte tidsrum (op til 20 minutter) for at skifte tøj eller varetage personlig hygiejne. Drøft planer for bad og vask med din læge.
- Forebyg, at Invia Liberty-pumpen bliver våd.
- Placer ikke Invia Liberty-pumpen et sted, hvor den kan falde ind i en brusekabine, ned i en håndvask eller et badekar.
- Rør ikke ved Invia Liberty-pumpen, hvis den er faldet i vandet. Tag straks stikket til produktet ud af stikkontakten, og kobl pumpen fra bandagen.

Når du forlader huset



- Kontrollér batteriets status, og genoplad det om nødvendigt, før du forlader huset.
- For at gøre det praktisk for dig kan du anbringe Invia Liberty-pumpen i bæretasken.
- Glem ikke at medbringe en ekstra beholder og strømforsyningen.

Opsætningsanvisninger



ADVARSEL

Kontrollér Invia Liberty-pumpen og bandagen hyppigt for at sikre dig, at den virker. Efterse sårbandagen, området omkring såret og væsken i beholderen for tegn på infektion eller andre komplikationer ifølge sin læges anvisninger.

Tænd

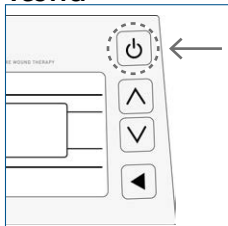

Tænd for Invia Liberty-pumpen ved at trykke på [].

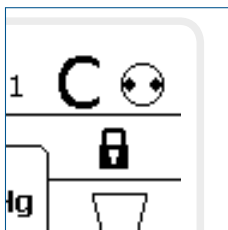

Displayets visning, når pumpen er i gang. Kør/standby-indikatoren drejer rundt [].



ADVARSEL

Forsøg ikke at udføre behandlingen uden din læges tilsyn.



ADVARSEL

NPWT skal være i gang 24 timer i døgnet. Du må ikke standse behandlingen, medmindre din læge siger, at du skal, eller hvis der opstår kraftig blødning.



ADVARSEL

Hvis behandlingen afbrydes i mere end 2 timer, skal bandagen udskiftes, og behandlingen skal genstartes af lægen.



ADVARSEL

Invia Liberty-pumpen registrerer ikke tilstopninger i den slange, der er tilsluttet drænadapteren eller tilsluttet den krumme del af Y-samlingen. Kontrollér bandageslangen, der er tilsluttet drænadapteren eller den krumme del af Y-samlingen, hyppigt i løbet af dagen for at sikre dig, at slangen ikke er knækket eller tilstoppet.

Hvis du opdager en tilstopning i slangen, der er tilsluttet drænadapteren, eller slangen, der er tilsluttet den krumme del af Y-samlingen, skal du kontakte din læge.

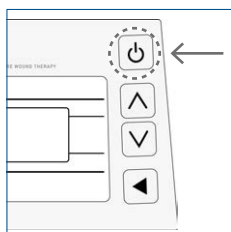

Sluk

Sluk for Invia Liberty-pumpen ved at trykke på [] i 3 sekunder. Tryk kun én gang.

Opsætning af bæretasken

Invia Liberty-pumpen er beregnet til at blive opbevaret i bæretasken under drift.



- 1 Åbn bæretasken.
- 2 Læg Invia Liberty-pumpen ned i den dertil indrettede lomme.
- 3 Luk velcroen over pumpen.

Skulderremmen kan også bruges som et bælte.

Dette gøres ved at tage remmen af bæretaskens sider og trække den igennem de to stropper, der sidder på bæretaskens bagside.

Opladning af batteri

Når batteriet er fuldt opladet, er batteridriftstiden som hovedregel over 14 timer. Hvis Invia Liberty-pumpen kører konstant på grund af en luftlækage, skal batteriet måske genoplades tidligere.

Batteristatussymboler



fuldt



halvt fuldt



fuldt afladet (tomt)

Hvis batteriet aflades helt (tømmes), skal nedenstående anvisninger følges.

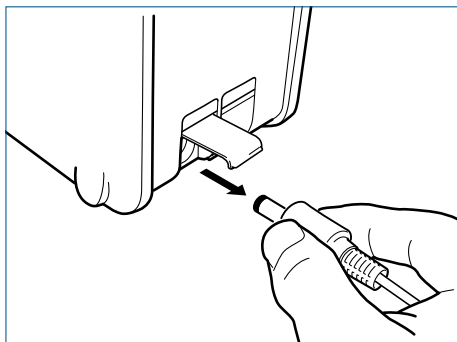

Åbn strømudgangen. Tilslut Invia Liberty-pumpen til strømstikket på den strømforsyning, der fulgte med pumpen. Sæt den anden ende af strømforsyningen i en stikkontakt. Bjælkerne på batteri-displayet bevæger sig for at vise, at opladningen er i gang.

Batteriet er fuldt opladet efter ca. 4 timer. Når batteriet er fuldt opladet og fortsat er tilsluttet en strømkilde, vil  vises konstant på displayet. Når opladningen er gennemført, tages strømstikket ud af stikkontakten, og Invia Liberty-pumpen kobles fra strømforsyningen.

Luk strømudgangen ved at trykke det beskyttende dæksel ned.



FORSIGTIG

NPWT-behandlingen skal fortsættes, mens pumpens batteri oplades. Pumpen må ikke slukkes, mens den oplades.

Oplad altid batteriet i løbet af natten.





Udskift beholderen

Udskift beholderen mindst en gang om ugen, eller når den ser ud til at være fuld, eller når alarmen lyder, i overensstemmelse med anvisningerne på pumpens display.

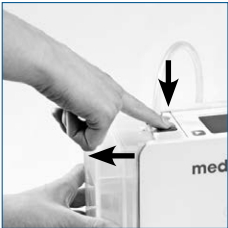
- 1 Vask hænder.
- 2 Tryk på knappen "Standby" [ > 3 sekunder], og motoren i pumpen holder op med at køre.

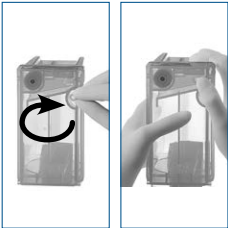
- 3  Tryk på udløserknappen oven på pumpen, og fjern beholderen.

- 4  Luk den brugte beholder med en hætte, der sidder på siden af beholderen.

- 5  Pak den nye beholder ud, fjern sikkerhedsmærkatens, og anbring fødderne i bunden af beholderen i rillerne i bunden af pumpen. Skub beholderen op, og klik den ind i Invia Liberty-pumpen.

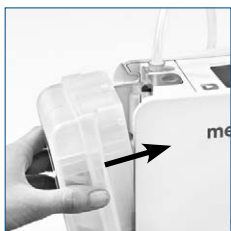

FORSIGTIG

En Invia Liberty-beholder må ikke anvendes, hvis den sterile emballage er beskadiget.

6



Tænd for Invia Liberty-pumpen ved at trykke på knappen "On" [] (tænd) for at genoptage behandlingen, og anbring pumpen i bæretasken.

7 Bortskaf den brugte beholder i overensstemmelse med din læges anvisninger.

Tilslut/frakobl quick-samlingen

Quick-samlingen kan frakobles i korte tidsrum (op til 20 minutter) for at skifte tøj eller varetage personlig hygiejne. I dette tidsrum kan pumpen sættes i "Standby"-tilstand i 5 minutter ad gangen, hvorefter alarmen for "Standby mode" (standbytilstand) vil lyde, og denne kan slås fra i yderligere 5 minutter.

1 Vask hænder.

2 Luk klemmen på beholderslangen, og luk klemmen på bandageslangen.



3 Tryk på knappen "Standby" [ > 3 sekunder], og motoren i pumpen holder op med at køre.

4

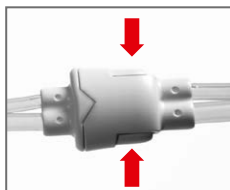

Frakobl quick-samlingen ved at trykke på samlingens sider.

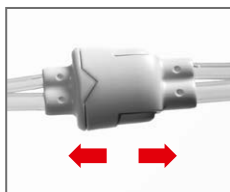

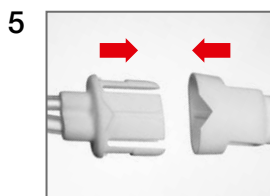

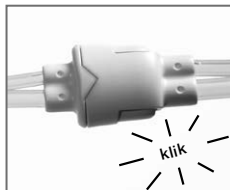

Quick-samlingen tilsluttes igen ved at trykke quick-samlingen sammen, indtil du hører klikket.

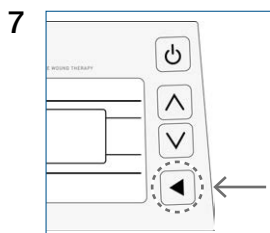

Åbn klemmen på beholderslangen, og åbn klemmen på bandageslangen.



Tryk på "On" [] (tænd) for at genoptage behandlingen.

Meddelelser og fejlfinding



Gå ikke i panik, hvis der lyder en alarm.
Følg nedenstående vejledning.

- 1 Hvis Invia Liberty-pumpen er i bæretasken, skal du åbne låget på bæretasken.
- 2 Tryk på [] for at slå alarmlyden fra i 60 sekunder (du kan trykke på den, hver gang alarmeren lyder).

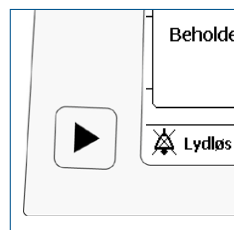

Alarmoversigt

Advarsel	401	<p>Batteri næsten fladt</p> <p>401</p> <p>Lydløs Standby (3 sek.)</p>	<p>Oplad batteri</p> <p>401</p> <p>Lydløs Standby (3 sek.)</p>
	405	<p>Standbytilstand</p> <p>405</p> <p>Lydløs Til</p>	<p>Tænd eller sluk for pumpen</p> <p>405</p> <p>Lydløs Til</p>
	406	<p>Intern temperatur høj</p> <p>406</p> <p>Lydløs Standby (3 sek.)</p>	<p>Fjern pumpen fra varmekilden (f.eks. direkte sollys), eller fjern yderligere tildækning (f.eks. tæppe).</p> <p>406</p> <p>Lydløs Standby (3 sek.)</p>
Alarm	301	<p>Lækage i systemet</p> <p>301</p> <p>Lydløs Standby (3 sek.)</p>	<p>Kontrollér system for lækager.</p> <p>Ved yderligere spørgsmål, se vedlagte brugsanvisning.</p> <p>301</p> <p>Lydløs Standby (3 sek.)</p>
	302	<p>System tilstoppet</p> <p>302</p> <p>Lydløs Standby (3 sek.)</p>	<p>Kontrollér, at slangen er ren og ikke bukket. Kontrollér, om beholderen er fuld.</p> <p>Se brugsanvisningen ved yderligere spørgsmål.</p> <p>302</p> <p>Lydløs Standby (3 sek.)</p>

Bemærkninger/mulig fejlårsag

Genoplad batteriet ved enten at placere Invia Liberty-pumpen i ladestationen eller sætte opladerstikket i pumpens strømudgang.

Tilbageværende batteritid ca. 30 minutter.

Hvis pumpen er i standbytilstand i mere end 5 minutter, vil der lyde en alarm.

Behandlingen genoptages ved at trykke på "On" [] (tænd).

Køl Invia Liberty-pumpen ned ifølge anvisningerne på displayet.

Bandage:

- Kontrollér bandagen for luftlækage. Tryk fast ned omkring bandagens kanter, rundt om drænslangen eller på Invia FitPad.
- Sæt eventuelt ekstra filmbandage på for at forsegle utæthed.

Samlinger:

- Sørg for, at den slange, der er tilsluttet bandagen, er tilsluttet korrekt til beholderslangen.
- Sørg for, at beholderslangen er sat lige ind i pumpen.

Beholder

- Sørg for, at beholderen er korrekt indsat, frigør beholderen og sæt den i igen.
- Sørg for, at den orange O-ring/pakning, der sidder ved siden af beholderslangen på pumpen, ikke mangler. Yderligere O-ringe kan fås gennem Medela repræsentant.

Ring til din læge.

Alarm	305			
	306			
	311			
	313			
Intern fejl				



FORSIGTIG

Hvis du ikke kan identificere et eller flere symboler, eller hvis du ikke forstår alarmen på displayet, skal du kontakte din læge.

Bemærkninger/mulig fejlårsag	
	<p>Genoplad batteriet ved enten at placere Invia Liberty-pumpen i ladestationen eller sætte opladerstikket i pumpens strømudgang.</p> <p>Tilbageværende batteritid ca. 15 minutter.</p>
	<p>Udskift beholderen, se kapitlet “Udskift beholder”.</p>
	<p>Beholder - Frigør beholderen, og sæt den i igen. Slange: - Sørg for, at slangen ikke er vredet, knækket eller afklemt.</p>
	<p>Udskift beholderen, se kapitlet “Udskift beholder”.</p>
	<p>Genstart pumpen. Hvis alarmen Intern fejl ikke forsvinder, skal du slukke ved at trykke på [ > 3 sekunder] og kontakte din læge.</p>



ADVARSEL

Hvis pumpen svigter eller ikke kan tændes, skal du straks ringe til din læge.

Rengøring/desinfektion



Invia Liberty-pumpen kan tørres af med en fugtig klud og et mildt universalrengøringsmiddel.

Garanti



Garantiperioden er 2 år fra udleveringsdatoen. Producenten kan ikke drages til ansvar for nogen former for skader eller senere skader, som er forårsaget af forkert betjening, u hensigtsmæssig anvendelse samt betjening udført af uautoriserede personer.

Vedligeholdelse/sikkerhedsrelaterede eftersyn



Servicearbejde må kun udføres af autoriseret personale. Et sikkerhedsrelateret eftersyn begrænser sig til visuelt eftersyn af kabinettet/huset og opladeren for eventuelle skader og skal foretages før hver brug. Hvis Invia Liberty-pumpen ikke har været i brug, skal batteriet oplades omtrent hver 6. måned for at sikre, at den fungerer optimalt.

Bortskaffelse



Spørg sundhedspersonalet, hvordan brugte bandager, beholdere og slanger skal bortskaffes.

Tekniske specifikationer



Opbevaringsbetingelser for tilbehør

Tilbehøret skal blive i emballagen og opbevares ved en temperatur på mellem -20 °C og +50 °C.



Driftsmiljøbetingelser

Invia Liberty-pumpen og tilbehøret skal anvendes inden for et temperaturinterval på +5 °C til +40 °C. Produkterne må ikke anvendes i ekstrem kulde eller varme. Undgå høj relativ luftfugtighed (15-93 % er tilladt).



FORSIGTIG

Invia Liberty-pumpen må ikke anvendes mere end 3000 meter over havets overflade.

Kapslingsklasse IP33

IP33

Invia Liberty-pumpen er beskyttet mod indtrængen af partikler, der er større end 2,5 millimeter, og dryppende vand

Tegn og symboler



Dette symbol markerer en FORHOLDSREGEL eller ADVARSEL vedrørende produktet.



Dette symbol markerer et produkt i klasse II.



Enheden ikke må bortskaffes sammen med usorteret kommunalt affald (gælder kun i EU).



Dette symbol markerer produktionsdatoen (fire cifre for år og to cifre for måned).



Dette symbol markerer navn og adresse på producenten.

STERILEEO

Dette symbol markerer, at produktet er steriliseret med ethylenoxid.

R_xonly

Dette symbol markerer, at der er tale om en receptpligtig enhed. BEMÆRK: Ifølge amerikansk lovgivning må denne anordning kun sælges til en læge eller efter lægeordination (kun for USA).



Dette symbol markerer en patientdel type BF.

REF

Dette symbol angiver producentens katalognummer.

SN

Dette symbol markerer producentens serienummer.

LOT

Dette symbol markerer producentens batchkode.

IP33

Dette symbol markerer beskyttelsen mod indtrængen af faste fremmedlegemer og imod skadelige virkninger efter indtrængen af vand.



Dette symbol markerer, at produktet ikke må anvendes efter udløb af den angivne dato.



Dette symbol markerer, at brugsanvisningen skal følges.



Dette symbol markerer overensstemmelse med de ekstra sikkerhedskrav til elektromedicinsk udstyr i USA og Canada.



Dette symbol markerer, at produktet ikke må anvendes, hvis emballagen er beskadiget.

pcs

Dette symbol markerer antal emner.



Dette symbol markerer jævnstrømsstikdåsen.



Dette symbol markerer, at det mærkede produkt eller dets materiale indgår i en genindvindings/genbrugsproces.



Dette symbol angiver luftfugtighedsgrænsen for drift og opbevaring.



Dette symbol angiver grænsen for atmosfærisk tryk ved drift og opbevaring.



Dette symbol markerer, at produktet skal holdes tørt.



Dette symbol markerer, at produktet ikke må udsættes for sollys.



Dette symbol markerer, at produktet er skrøbeligt og skal håndteres forsigtigt.



Dette symbol markerer, at der er tale om et produkt til engangsbrug. Produktet må ikke genbruges.



Dette symbol markerer temperaturbegrænsningen for drift, transport og opbevaring.



Dette symbol markerer, at produktet opfylder kravene i direktiv 93/42/EØF om medicinsk udstyr.



Dette symbol markerer den korrekte oprette position for transportkassen.

Elektromagnetisk kompatibilitet (EMC)

Invia Liberty er EMC-testet i overensstemmelse med kravene i IEC 60601-1-2:2007 og IEC 60601-1-2:2014 4. udgave ifølge afsnit 7 og 8.9.



ADVARSEL

Invia Liberty-pumpen må ikke anvendes op ad eller stablet sammen med andet udstyr. Hvis det alligevel er nødvendigt, skal Invia Liberty-pumpen være under observation for at sikre, at systemet fungerer normalt i den konfiguration, hvor det skal anvendes.



ADVARSEL

Der må ikke anvendes andet tilbehør end det, der er specificeret af eller som sælges af producenten til udskiftning af indvendige komponenter, da dette kan medføre øgede emissioner fra Invia Liberty-pumpen eller forringe dens immunitet.



ADVARSEL

EMC

Højfrekvent (HF) kirurgisk udstyr, radionetværk og lignende kan påvirke apparatets drift og må ikke anvendes sammen med Invia Liberty-pumpen.

Assistanse

Les hele bruksanvisningen før du prøver å bruke apparatet.

Hvis du har spørsmål om ditt Invia Liberty-system for sårbehandling med undertrykk, kan du kontakte ditt helsepersonell / legen din på nummeret nedenfor:

HELSEPERSONELL/LEGE
KONTAKTINFORMASJON:

Oppbevar dette heftet med bruksanvisning på et lett tilgjengelig sted.

Innhold

Advarsler, forsiktighetsregler og sikkerhetsinstruksjoner	284
Generelle advarsler.....	284
Formål med apparatet	286
Tilsiktet bruk.....	286
Når skal du bruke apparatet (indikasjoner for bruk)	287
Når skal du ikke bruke apparatet (kontraindikasjoner)	287
Beskrivelse av apparatet	288
Display	289
Forhold som påvirker bruken	289
Generell sikkerhet i hjemmet	290
Søvn	291
Dusjing, bading og vasking	291
Når du går ut av huset	292
Oppsettanvisning	292
Sette opp bærevekke	294
Lade opp batteriet	294
Skifte beholder	296
Koble til/fra hurtigkobling	297
Varsler og feilsøking	299
Alarmtabell	300
Rengjøring/desinfisering	304
Garanti	304
Vedlikehold / sikkerhetsrelaterte kontroller	304
Avfallshåndtering	304
Tekniske spesifikasjoner	305
Tegn og symboler	306
Elektromagnetisk kompatibilitet (EMC)	309

Advarsler, forsiktighetsregler og sikkerhetsinstruksjoner



ADVARSEL

Indikerer en potensielt farlig situasjon, som kan føre til død eller alvorlig personskade hvis den ikke unngås.



FORSIKTIG

Indikerer en potensielt farlig situasjon, som kan føre til mindre eller moderate personskader hvis den ikke unngås.

Generelle advarsler



ADVARSEL

Personen som er ansvarlig for å bruke dette apparatet på daglig basis (pasient, pleier), må kunne lese, forstå og følge anvisningene i denne bruksanvisningen, på pumpeskjermen og fra helseinstitusjonen. Personen må kunne høre og reagere på lydsignaler. Bruk bare Invia Liberty NPWT-systemet på personen som den ble bestilt til, og bare til det formålet den er ment for. Ikke utfør behandlingen uten først å rådføre deg med helsepersonell og pleiere som har fått opplæring i bruksanvisningen samt under tilsyn av helsepersonell. Det er ikke tillatt å foreta endringer på dette utstyret.



ADVARSEL

Kontroller visuelt sårforbindingen og Invia Liberty-systemet hyppig. Hvis du ser store mengder blod under forbindingen, slangene eller beholderen:

- 1 Slå av pumpen ved å trykke på  og holde inne i 3 sekunder.
- 2 Påfør trykk på såret.
- 3 Oppsøk øyeblikkelig medisinsk hjelp.



Hvis du har pustevansker skal du oppsøke øyeblikkelig medisinsk hjelp.

ADVARSEL

Kontakt helsepersonell umiddelbart hvis du opplever noen av følgende symptomer:

- Betydelig syns- eller hørselstap
- Smerte, ømhet eller rødhet rundt såret
- Hevelse, kløe eller utslett rundt såret
- Feber
- Sterk lukt fra såret
- Tykk, grønn væske eller uvanlig endring i væskens farge
- Kvalme, oppkast eller diaré
- Sår og hoven hals
- Svimmelhet eller forvirring
- Allergiske reaksjoner som rødhet, utslett eller elveblest, hevelse eller alvorlig kløe

ADVARSEL

Når helsepersonell har stilt inn pumpetrykket og modusinnstillinger, må du ikke trykke på andre knapper enn på/av-knappen [], standbyknappen [] eller dempeknappen [].

ADVARSEL

Pumpen må brukes 24 timer i døgnet. Ikke stopp pumpen med mindre du har fått beskjed om det fra helsepersonell, eller hvis det oppstår kraftig blødning.

Hvis pumpen stoppes i mer enn 2 timer, skal forbindingen skiftes. Kontakt helsepersonell for å be om å få byttet forbindelse.

ADVARSEL

Hvis pumpen slutter å virke og ikke kan slås på, må du kontakte helsepersonell umiddelbart.

Formål med apparatet

Helsepersonell har forskrevet sårbehandling med undertrykk (NPWT) for deg.

Sårbehandling med undertrykk er dokumentert å fremme tilheling av flere ulike typer sår. Undertrykk (sug) leveres til et sår via en pumpe. Suget, eller undertrykket, bidrar til å fjerne væske og lukke såret. Helsepersonellet vil legge en spesialforbinding på såret ditt, og det vil gå en slange fra såret til beholderen på pumpen. Deretter slås pumpen på til det forskrevne trykket for å fjerne væske fra såret. Væsken føres inn i beholderen. Behandlingen vil være på 24 timer i døgnet.

Tilsiktet bruk

Tiltenkt bruker

Invia Liberty NPWT-systemet er beregnet for bruk av helsepersonell eller ufaglærte brukere med tilstrekkelig opplæring.

Helsepersonell er ansvarlig for å lære opp ufaglærte brukere i samsvar med bruksanvisningen for pasienter, og forklare all relevant sikkerhetsinformasjon.

Tiltenkt pasientgruppe

Invia Liberty NPWT-systemet er kun beregnet på bruk på pasienter som har de tilstandene som er beskrevet i indikasjonene for bruk. Apparatet er ikke studert på pediatriske pasienter.

Tiltenkt miljø

Invia Liberty NPWT-systemet er ment for bruk ved akutt eller forlenget pleie i sykehus samt hjemmepleie.

Når skal du bruke apparatet (indikasjoner for bruk)

Invia Liberty sårbehandlingssystem med undertrykk (NPWT) er indisert for pasienter som vil dra nytte av en sugeenhet (sårbehandling med undertrykk), da det skaper et miljø som fremmer sårtilhelingen ved sekundær eller tertiær (forsinket primær) intensjon ved å forberede sårsengen for lukking, redusere ødem, styrke dannelse av granulasjonsvev og perfusjon, og ved å fjerne sårveske og infeksiose stoffer.

Når Invia Liberty NPWT-systemet brukes på lukkede kirurgiske innsnitt, er det også ment for å kontrollere miljøet til kirurgiske innsnitt som fortsetter å væske etter suturering eller stifting, ved å opprettholde et lukket miljø og fjerne eksudat ved bruk av sårbehandling med undertrykk.

Invia Liberty NPWT-systemet er egnet for bruk ved følgende indikasjoner:

- Akutte eller subakutte sår
- Kroniske sår
- Åpne sår
- Trykksår
- Diabetiske/nevropatiske sår
- Venøs insuffisiens-sår
- Traumatiske sår
- Brannsår med delvis tykkelse
- Fliker og grafter
- Lukkede kirurgiske innsnitt

Når skal du ikke bruke apparatet

(kontraindikasjoner)

Invia Liberty NPWT-systemet er kontraindisert når det finnes:

- Nekrotisk vev med sårskorpe
- Ubehandlet osteomyelitt
- Ikke-enteriske og utforskede fistler
- Malignitet i såret
- Eksponert vaskulatur
- Eksponerte nerver
- Eksponert anastomose ved blodkar eller bypass
- Eksponerte organer

Hvis du har spørsmål, kan du snakke med helsepersonell.

Beskrivelse av apparatet

Kontroller at den leverte pakken med Invia Liberty-systemet er komplett og i god stand.



ADVARSEL

Ikke bruk noe annet tilbehør enn det som er beskrevet nedenfor.

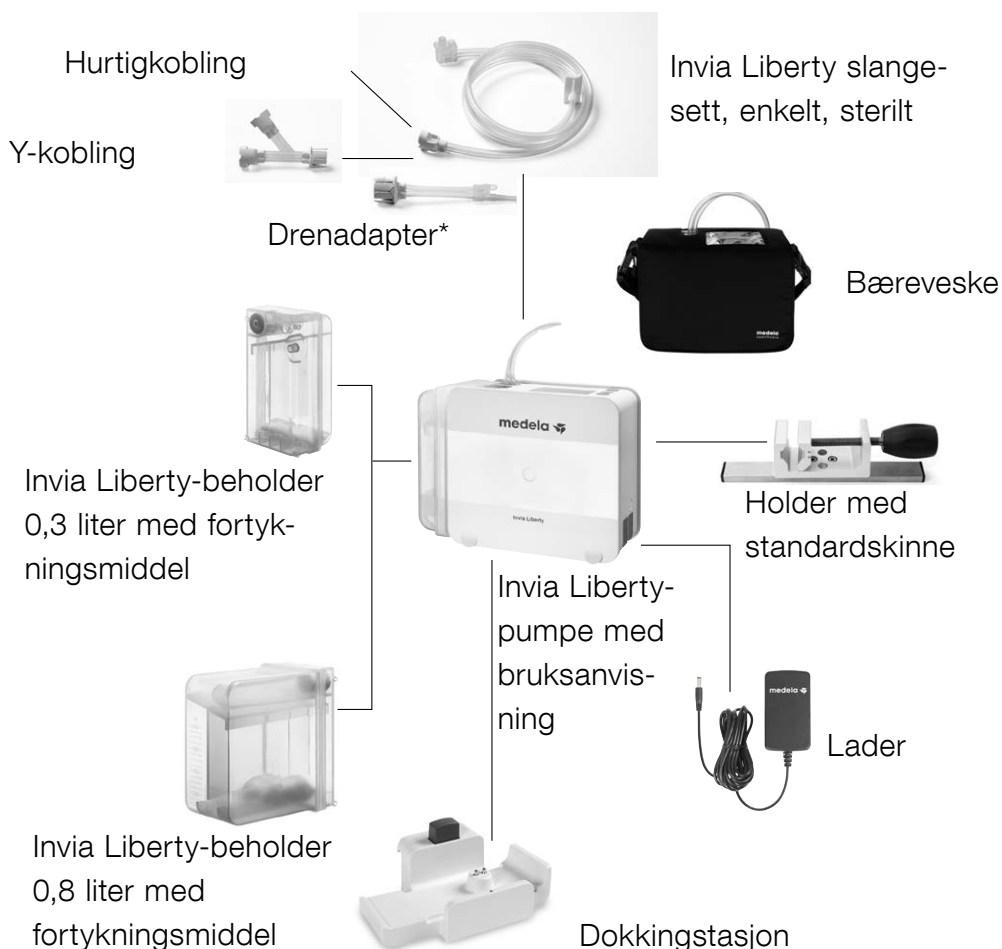

*Produktet er ikke tilgjengelig i alle land

Display

Knapper for å bruke Invia Liberty-pumpen

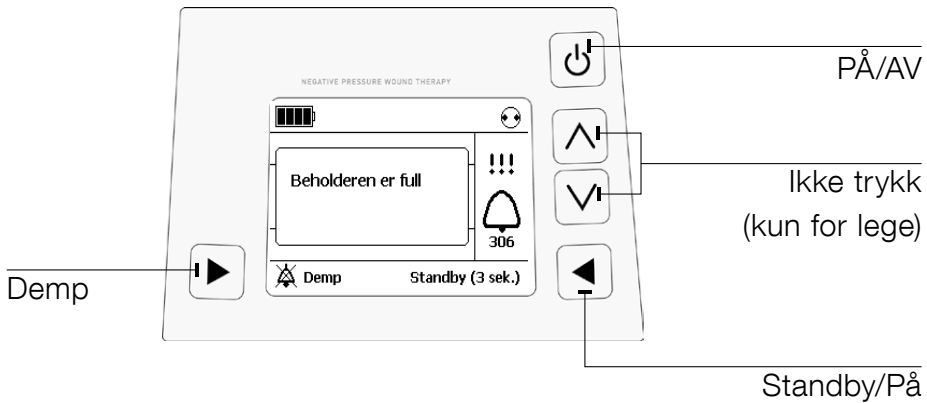

Forhold som påvirker bruken



FORSIKTIG

Invia Liberty-pumpen må stå oppreist når den er i bruk.



Generell sikkerhet i hjemmet



Vennligst les og ta hensyn til disse advarslene og sikkerhetsinstruksjonene før bruk. Denne bruksanvisningen skal oppbevares sammen med apparatet. Vær oppmerksom på at denne bruksanvisningen er en generell veiledning til bruk av produktet. Medisinske spørsmål skal avgjøres av lege.



FORSIKTIGHETSREGLER/ADVARSLER

- Bruk ikke skjoteledninger til Invia Liberty-pumpen.
- Legg strømledningen slik at ingen faller eller snubler i den.
- Legg aldri strømledningen rundt halsen.
- Hold strømledningen unna varme overflater.
- Trekk aldri støpselet ut av stikkkontakten ved å trekke i strømledningen.
- Ikke prøv å reparere Invia Liberty-pumpen. Kontakt helsepersonell hvis pumpen ikke virker.
- Hold Invia Liberty-pumpen ren og tørr.
- Sett aldri Invia Liberty-pumpen i vann eller væske.
- Hvis Invia Liberty-pumpen blir våt, tørker du den med et tørt håndkle.
- Invia Liberty må ikke tørkes i mikrobølgeovn.
- Hold Invia Liberty-pumpen unna barn og kjæledyr.
- Når Invia Liberty-pumpen brukes i nærheten av barn, skal den være under oppsyn.
- Beskytt Invia Liberty-pumpen mot direkte sollys.
- Eksplosjonsfare – Invia Liberty-pumpen skal ikke brukes i potensielt eksplosive miljøer, inkludert oksygenberikede miljøer og i områder med brennbare anestesigasser.
- Trådløst kommunikasjonsutstyr som trådløse hjemmenettverk, mobiltelefoner, trådløse telefoner og deres basestasjoner samt walki-talkier kan påvirke Invia Liberty-pumpen og bør holdes minst 30 cm unna Invia Liberty-pumpen. Dette kan forårsake utilstrekkelig batterilading eller en intern feil. Se kapittelet Varsler og feilsøking for å se hva du skal gjøre ved en intern feil.

- Dette produktet inneholder litiumion-batterier som utgjør en fare for brann, eksplosjon og brannskader. Ikke demonter, knus, varm opp over 100 °C, brenn eller kast i ild.

Hvis du oppdager en endring i vakuumnivået eller en feiltilstand, skal du flytte Invia Liberty-pumpen minst 30 cm unna mobiltelefonen når du ringer eller noen ringer deg. Slå Invia Liberty-pumpen på og av igjen for å nullstille den etter en feiltilstand. Når det er mulig, anbefales det en sikkerhetsavstand på minst 30 cm mellom Invia Liberty-pumpen og en mobiltelefon.

Søvn



- Pass på at det ikke blir knekk på Invia Liberty-slangesettet.
- Pass på at Invia Liberty-pumpen ikke faller i gulvet mens du sover.
- Lad alltid Invia Liberty-pumpen når du legger deg.

Dusjing, bading og vasking



- Ikke bruk Invia Liberty-pumpen mens du bader eller dusjer.
- Invia Liberty-pumpen kan kobles fra forbindingen i en kort periode (opptil 20 minutter) slik at du kan skifte klær eller utføre personlig hygiene. Snakk med helsepersonell om hvordan du skal bade.
- Pass på at Invia Liberty-pumpen ikke blir våt.
- Ikke plasser Invia Liberty-pumpen slik at den kan falle ned i dusjen, vasken eller badekaret.
- Ikke berør Invia Liberty-pumpen hvis den har falt ned i vann. Trekk umiddelbart støpselet ut av stikkkontakten og koble pumpen fra forbindingen.

Når du går ut av huset



- Sjekk batteristatusen og lad opp hvis det trengs før du forlater huset.
- Sett Invia Liberty-pumpen i bæreveksen, slik at det blir praktisk for deg.
- Ikke glem å ta med deg en ekstra beholder og strømforsyning.

Oppsettanvisning



ADVARSEL

Kontroller Invia Liberty-pumpen og forbindingen ofte, slik at du er sikker på at den virker. Kontroller visuelt sårforbindingen, området rundt såret og væsken i beholderen for å se etter tegn på infeksjon eller andre komplikasjoner, slik du har fått beskjed om fra helsepersonell.

Slå PÅ

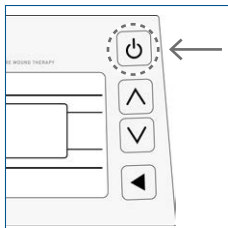

Slå PÅ Invia Liberty-pumpen ved å trykke på [].

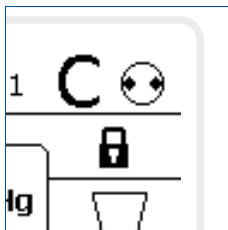

Skjermvisning når pumpen kjører. Drifts-/standbyindikatoren roterer [].



ADVARSEL

Ikke prøv å utføre behandling uten tilsyn fra helsepersonell.



ADVARSEL

NPWT må kjøre 24 timer i døgnet. Ikke stopp behandlingen med mindre du har fått beskjed om det fra helsepersonell, eller hvis det oppstår kraftig blødning.



ADVARSEL

Hvis behandlingen avbrytes i mer enn 2 timer, skal forbindningen skiftes og behandlingen startes på nytt av helsepersonell.



ADVARSEL

Invia Liberty-pumpen oppdager ikke blokkeringer langs slangen som er koblet til drenadapteren eller til den bøyde armen på Y-koblingen. Kontroller ofte forbindingsslangen som er koblet til drenadapteren eller til den bøyde armen på Y-koblingen, gjennom hele dagen, for å sikre at det ikke er knekk på slangen og at den ikke er blokkert.

Kontakt helsepersonell hvis du oppdager blokkeringer langs slangen som er koblet til drenadapteren eller slangen som er koblet til den bøyde armen på Y-koblingen.

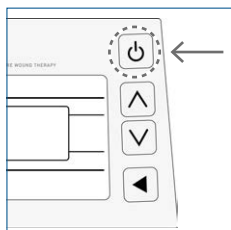

Slå AV

Slå AV Invia Liberty-pumpen ved å trykke på [] i 3 sekunder. Trykk bare én gang.

Sette opp bæreveske

Invia Liberty-pumpen er ment for å bæres i bærevesken under bruk.



- 1 Åpne bærevesken.
- 2 Sett Invia Liberty-pumpen inn i den tiltenkte lommen.
- 3 Lukk borrelåsen over pumpen.

Skulderstroppen kan også brukes som beltestropp. Da løsner du stroppen på sidene av bærevesken og trekker den gjennom de to løkkene på baksiden av bærevesken.

Lade opp batteriet

Et helt oppladet batteri har vanligvis en driftstid på over 14 timer. Hvis Invia Liberty-pumpen kjører kontinuerlig på grunn av en luftlekkasje, kan det hende at batteriet må lades opp tidligere.

Symboler for batteristatus



fullt

halvfullt

helt utladet (tomt)

Følg instruksjonene nedenfor hvis batteriet blir helt utladet (tomt).

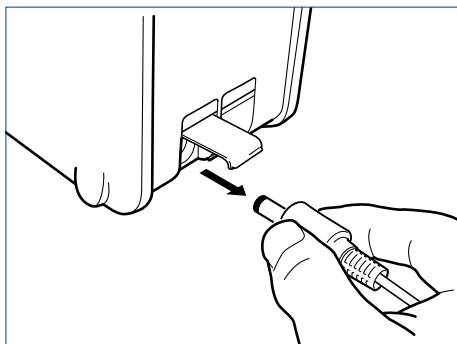

Åpne den elektriske uttaksporten. Koble Invia Liberty-pumpen til det medfølgende støpselet fra strømforsyningen som følger med pumpen. Sett den andre enden av strømforsyningen inn i en stikkontakt. Bevegende søyler på batteriskjermen viser at det lades opp.

Batteriet er helt oppladet etter ca. 4 timer. Når batteriet er helt oppladet og fortsatt er koblet til strømkilden, vises  kontinuerlig på skjermen. Etter at ladingen er fullført, skal du trekke ut støpselet fra stikkontakten og koble Invia Liberty-pumpen fra strømforsyningen.

Lukk den elektriske uttaksporten ved å trykke ned beskyttelsesdekselet.



FORSIKTIG

NPWT-behandling må fortsettes mens pumpens batteri lades. Ikke slå av pumpen under lading.

Lad alltid batteriet om natten.





Skifte beholder

Bytt beholder én gang i uka, når beholderen ser full ut eller når en alarm lyder, i samsvar med instruksjonene på pumpeskjermen.

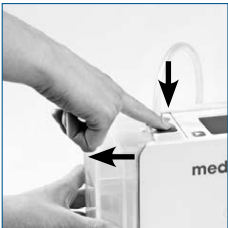
- 1 Vask hendene.
- 2 Trykk på «Standby»-knappen [ > i 3 sekunder] og pumpemotoren vil slutte å kjøre.

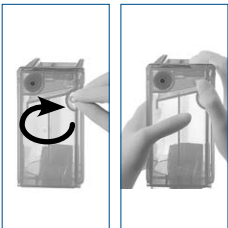
- 3  Trykk på utløserknappen øverst på pumpen og fjern beholderen.

- 4  Forsegl den brukte beholderen med en hette som finnes på siden av beholderen.

- 5  Pakk ut den nye beholderen og fjern sikkerhetsmerket, plasser bena nederst på beholderen i sporene nederst på pumpen. Skyv beholderen oppover og klikk den inn i Invia Liberty-pumpen.



FORSIKTIG

Ikke bruk Invia Liberty-beholderen hvis den sterile pakningen er skadet.

6



Slå på Invia Liberty-pumpen ved å trykke på «På» [] for å gjenoppta behandlingen og sett pumpen inn i bæreevesken.

7 Kast den brukte beholderen i samsvar med instruksjonene fra helsepersonellet.

Koble til/fra hurtigkobling

Hurtigkoblingen kan kobles fra i en kort periode (opptil 20 minutter) slik at du kan skifte klær eller utføre personlig hygiene. I denne perioden kan pumpen settes i «Standby»-modus i et intervall på 5 minutter, deretter vil «Standbymodus»-alarmen lyde. Den kan dempes i ytterligere 5 minutter.

- 1 Vask hendene.
- 2 Lukk klemmen på beholder-slangen og lukk klemmen på forbindingsslangen.
- 3 Trykk på «Standby»-knappen [] i >3 sekunder] og pumpemotoren vil slutte å kjøre.



4

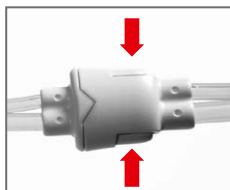

Koble fra hurtigkoblingen ved å trykke under sidene på hurtigkoblingen.

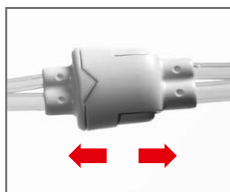

5

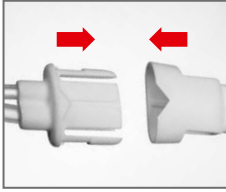

For å koble til hurtigkoblingen igjen, skyver du sammen hurtigkoblingen til du hører et klikk.

6



Åpne klemmen på beholderslangen og åpne klemmen på forbindingsslangen.

7

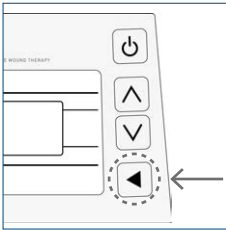

Trykk på «På» [] for å gjenoppta behandlingen.

Varsler og feilsøking



Ikke få panikk hvis du hører et lydsignal.
Følg instruksjonene nedenfor.

- 1 Hvis Invia Liberty-pumpen er i bæreveesken, skal du åpne lokket på bæreveesken.
- 2 Trykk på [] for å dempe lydsignalet i 60 sekunder (du kan trykke hver gang signalet lyder).

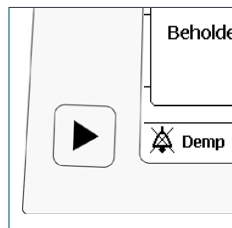

Alarmtabell

Advarsel	401	<p>Batteri lavt</p> <p>401</p> <p>Demp Standby (3 sek.)</p>	<p>Lad batteriet</p> <p>401</p> <p>Demp Standby (3 sek.)</p>
	405	<p>Standby-modus</p> <p>405</p> <p>Demp På</p>	<p>Slå pumpen på eller av</p> <p>405</p> <p>Demp På</p>
	406	<p>Høy innvendig temperatur</p> <p>406</p> <p>Demp Standby (3 sek.)</p>	<p>Fjern pumpen fra varmekilden (f.eks. direkte sollys), eller fjern eventuell tildekking (f.eks. et teppe).</p> <p>406</p> <p>Demp Standby (3 sek.)</p>
Alarm	301	<p>Luftlekkasje i systemet</p> <p>301</p> <p>Demp Standby (3 sek.)</p>	<p>Kontroller systemet for lekkasjer og at beholderen er satt i korrekt.</p> <p>Konsulter IFU for ytterligere instruksjoner.</p> <p>301</p> <p>Demp Standby (3 sek.)</p>
	302	<p>Systemet er tilstoppet</p> <p>302</p> <p>Demp Standby (3 sek.)</p>	<p>Kontroller at det er passasje gjennom slangen og at den ikke er i klem. Kontroller om beholderne er fulle.</p> <p>Se flere instruksjoner i bruksanvisningen.</p> <p>302</p> <p>Demp Standby (3 sek.)</p>

Merknader / mulig årsak til feilen	
	<p>Lad batteriet ved enten å sette Invia Liberty-pumpen i dokkingstasjonen eller ved å sette laderen inn i den elektriske uttaksporten på pumpen.</p> <p>Gjenværende batteritid er ca. 30 minutter.</p>
	<p>Hvis pumpen er i standbymodus i mer enn 5 minutter, vil en alarm utløses.</p> <p>For å fortsette behandlingen trykker du på «På» [].</p>
	<p>Kjøøl ned Invia Liberty-pumpen i henhold til instruksjonene på skjermen.</p>
	<p>Forbinding:</p> <ul style="list-style-type: none"> – Kontroller forbindingen for luftlekkasje. Trykk godt ned rundt kantene på forbindingen, rundt drengslangen eller på Invia FitPad. – Legg på ekstra filmforbinding for å forsegle området med lekkasje. <p>Koblinger:</p> <ul style="list-style-type: none"> – Pass på at slangen som er koblet til forbindingen, er riktig koblet til beholderslangen. – Pass på at beholderslangen er satt rett inn i pumpen. <p>Beholder:</p> <ul style="list-style-type: none"> – Pass på at beholderen er satt riktig inn, utløs beholderen og juster plasseringen. – Pass på at den oransje o-ringen/pakningen som sitter ved siden av beholderslangen på pumpen, ikke mangler. Ekstra o-ring er tilgjengelig fra Medela kundeservice.
	<p>Kontakt helsepersonell.</p>

Alarm	305			
	306			
	311			
	313			
Intern feil				



FORSIKTIG

Kontakt helsepersonell hvis det er symboler eller alarmer på systemet du ikke forstår.

Merknader / mulig årsak til feilen	
	<p>Lad batteriet ved enten å sette Invia Liberty-pumpen i dokkingstasjonen eller ved å sette laderen inn i den elektriske uttaksporten på pumpen.</p> <p>Gjenværende batteritid er ca. 15 minutter.</p>
	<p>Bytt beholder, se kapittelet «Bytte beholder».</p>
	<p>Beholder: - Utløs beholderen og juster plasseringen. Slanger: - Pass på at slangene ikke er vridd, har knekk eller er klemt av.</p>
	<p>Bytt beholder, se kapittelet «Bytte beholder».</p>
	<p>Start pumpen på nytt. Hvis en intern feil vedvarer, skal du slå av ved å trykke på [ i >3 sekunder] og kontakte helsepersonell.</p>



ADVARSEL

Kontakt helsepersonell umiddelbart hvis pumpen svikter eller du ikke kan slå den på.

Rengjøring/desinfisering



Du kan tørke av Invia Liberty-pumpen med en fuktig klut og mildt husholdningsrengjøringsmiddel.

Garanti



Garantiperioden er 2 år fra leveringsdato. Produsenten har intet ansvar for skader eller følgeskader på grunn av feil behandling, uhensiktsmessig bruk eller betjening av ukvalifiserte personer.

Vedlikehold / sikkerhetsrelaterte kontroller



Servicearbeid skal bare utføres av autorisert personell.

En sikkerhetsrelatert kontroll er begrenset til visuell inspeksjon av huset og laderen for skade, og må utføres før hver bruk.

Hvis Invia Liberty-pumpen ikke har vært i bruk, må batteriet lades ca. hver 6. måned for å sikre optimal funksjon.

Avfallshåndtering



Kontakt helsepersonell for råd om kasting av brukte forbindinger, beholdere og slanger.

Tekniske spesifikasjoner



Oppbevaringsbetingelser for tilbehør

Tilbehøret skal oppbevares i emballasjen og lagres ved temperaturer mellom -20 °C og $+50\text{ °C}$.



Miljøbetingelser ved bruk

Invia Liberty-pumpen og tilbehøret må brukes i et temperaturområde mellom $+5\text{ °C}$ og $+40\text{ °C}$. Bruk ikke produktene i ekstrem kulde eller varme. Unngå høy luftfuktighet ($15\text{--}93\%$ er tillatt).



FORSIKTIG

Ikke bruk Invia Liberty-pumpen over 3000 meter over havet.

Beskyttelsesklasse IP33

IP33

Invia Liberty-pumpen er beskyttet mot inntrenging av faste elementer som er større enn 2,5 millimeter samt dryppende vann.

Tegn og symboler



Dette symbolet indikerer **FORSIKTIG** eller **ADVARSEL** forbundet med apparatet.



Dette symbolet angir et apparat i klasse II.



Ikke kast apparatet sammen med usortert husholdningsavfall (kun for EU).



Dette symbolet angir produksjonsdato (fire sifre for året og to sifre for måneden).



Dette symbolet angir produsentens navn og adresse.



Dette symbolet angir at apparatet steriliseres med etylenoksid.



Dette symbolet angir at dette er en reseptbelagt enhet. **FORSIKTIG**: Føderale lover i USA begrenser salg og bruk av dette apparatet til eller etter ordre fra lege (kun i USA).



Dette symbolet indikerer en anvendt del av type BF.



Dette symbolet indikerer produsentens katalognummer.



Dette symbolet indikerer produsentens serienummer.



Dette symbolet indikerer produsentens partikode.



Dette symbolet angir beskyttelse mot skadevirkninger som følge av inntrengning av faste fremmedelementer eller vann.



Dette symbolet angir at apparatet ikke skal brukes etter angitt måned og år.



Dette symbolet angir at bruksanvisningen må følges.



Dette symbolet indikerer samsvar med ytterligere sikkerhetskrav for medisinsk elektrisk utstyr i USA og Canada.



Dette symbolet indikerer at apparatet ikke skal brukes hvis emballasjen er skadet.

pcs

Dette symbolet angir antall deler.



Dette symbolet angir direktestrømsuttak.



Dette symbolet angir at den merkede delen eller dens materiale er en del av en gjenvinnings- eller resirkuleringsprosess.



Dette symbolet angir fuktighetsgrenser for drift og transport.



Dette symbolet angir grenser for atmosfæretrykk ved drift og transport.



Dette symbolet angir at apparatet må holdes tørt.



Dette symbolet angir at apparatet må holdes borte fra sollys.



Dette symbolet angir at apparatet må håndteres forsiktig.



Dette symbolet angir enhet for engangsbruk. Apparatet må ikke gjenbrukes.



Dette symbolet angir temperaturbegrensning for drift, transport og lagring.



Dette symbolet angir at apparatet samsvarer med Direktivet for medisinsk utstyr 93/42/EØF.



Dette symbolet indikerer riktig, stående posisjon for transportpakningen.

Elektromagnetisk kompatibilitet (EMC)

Invia Liberty er EMC-testet i overensstemmelse med kravene i IEC 60601-1-2:2007 og IEC 60601-1-2:2014, 4. utgave, i samsvar med punkt 7 og 8.9.



ADVARSEL

Invia Liberty-pumpen må ikke brukes ved siden av eller stablet med annet utstyr. Hvis Invia Liberty-pumpen må brukes stablet eller ved siden av annet utstyr, må den overvåkes for å sikre normal drift i den aktuelle konfigurasjonen.



ADVARSEL

Bruk ikke annet tilbehør enn det som er spesifisert av eller selges av produsenten ved utskifting av innvendige komponenter. Dette er for å unngå økte utslipp eller redusert immunitet for Invia Liberty-pumpen.



ADVARSEL

EMC

HF (høyfrekvent) kirurgisk utstyr, radionettverk eller lignende kan påvirke driften av apparatet og må ikke brukes sammen med Invia Liberty-pumpen.

Notes

Notes



Medela AG
Lättichstrasse 4b
6341 Baar, Switzerland
www.medelahealthcare.com

France

Medela France SAS
14 rue de la Butte Cordière
91154 Etampes Cedex
France
Phone +33 1 69 16 10 30
Fax +33 1 69 16 10 32
info@medela.fr
www.medela.fr

Germany & Austria

Medela Medizintechnik
GmbH & Co. Handels KG
Postfach 1148
85378 Eching
Germany
Phone +49 89 31 97 59-0
Fax +49 89 31 97 59 99
info@medela.de
www.medela.de

Italy

Medela Italia Srl a socio unico
Via Turrini, 13/15 – Loc. Bargellino
40012 Calderara di Reno (BO)
Italy
Phone +39 051 72 76 88
Fax +39 051 72 76 89
info@medela.it
www.medela.it

Netherlands & Belgium

Medela Benelux BV
Uilenwaard 31
5236 WB 's-Hertogenbosch
The Netherlands
Phone +31 73 690 40 40
Fax +31 73 690 40 44
info@medela.nl
info@medela.be
www.medela.nl
www.medela.be

Spain & Portugal

Productos Medicinales Medela, S.L.
C/ Llacuna, 22 4ª Planta
08005, Barcelona
Spain
Phone +34 93 320 59 69
Fax +34 93 320 55 31
info@medela.es
www.medela.es
info@medela.pt
www.medela.pt

Sweden

Medela Medical AB
Box 7266
187 14 Täby
Sweden
Phone +46 8 588 03 200
Fax +46 8 588 03 299
info@medela.se
www.medela.se

Switzerland

Medela AG
Lättichstrasse 7
6341 Baar
Switzerland
Phone +41 848 633 352
Fax +41 41 562 14 42
contact@medela.ch
www.medela.ch

United Kingdom

Medela UK Ltd.
Huntsman Drive
Northbank Industrial Park
Irlam, Manchester M44 5EG
United Kingdom
Phone +44 161 776 0400
Fax +44 161 776 0444
info@medela.co.uk
www.medelahealthcare.co.uk

International Sales

Medela AG
Lättichstrasse 4b
6341 Baar
Switzerland
Phone +41 41 562 51 51
Fax +41 41 562 51 00
customercare@medela.ch
www.medelahealthcare.com



If you need assistance contact